

Sperro

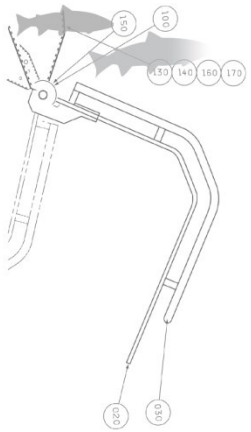

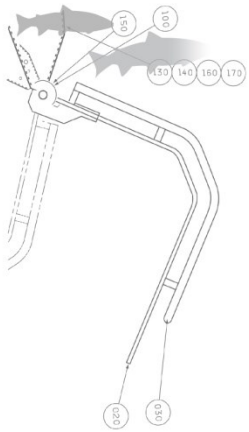

snurr film



Ja, men da er vel alt bra da
Endelig har vi kommet i mål!



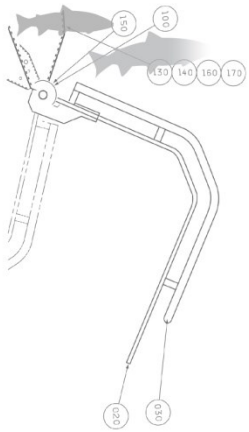

Nei, dessverre

- **Klem-armer, tretthetsbrudd (mulig produksjonsfeil) A**
- **Isolasjonsskive (problemet løst) B**
- **C-ring spøkelse**

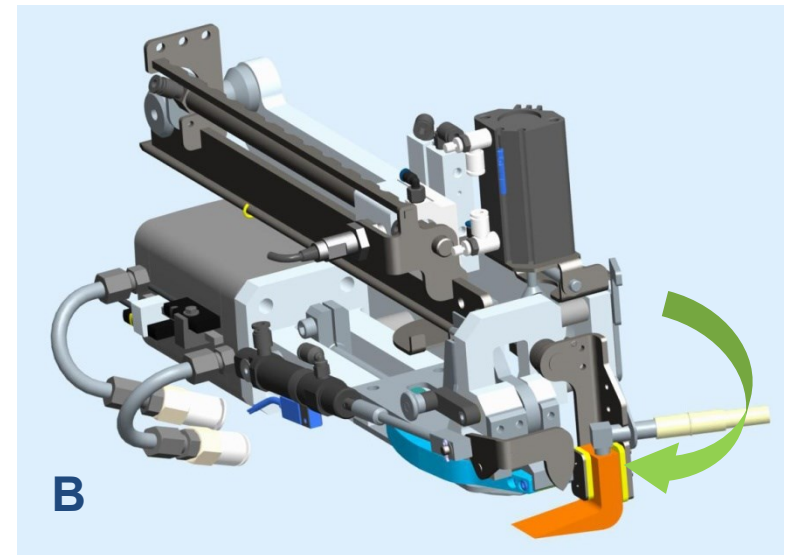

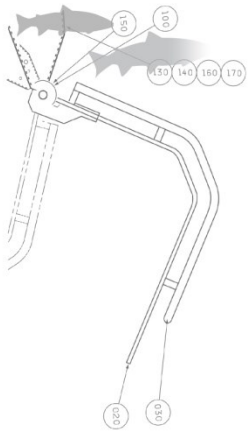

C-ring spøkelse

- Maskinene og klemverktøyet er identiske
- C-ringene er innenfor spesifikasjonene
- 2 produsenter, 6 produksjonsserier
- Én bestemt serie virker perfekt i en maskin, forårsaker litt rusk i en annen
- Lofoten, Vesterålen og Røst varianter?



C-ring spøkelse

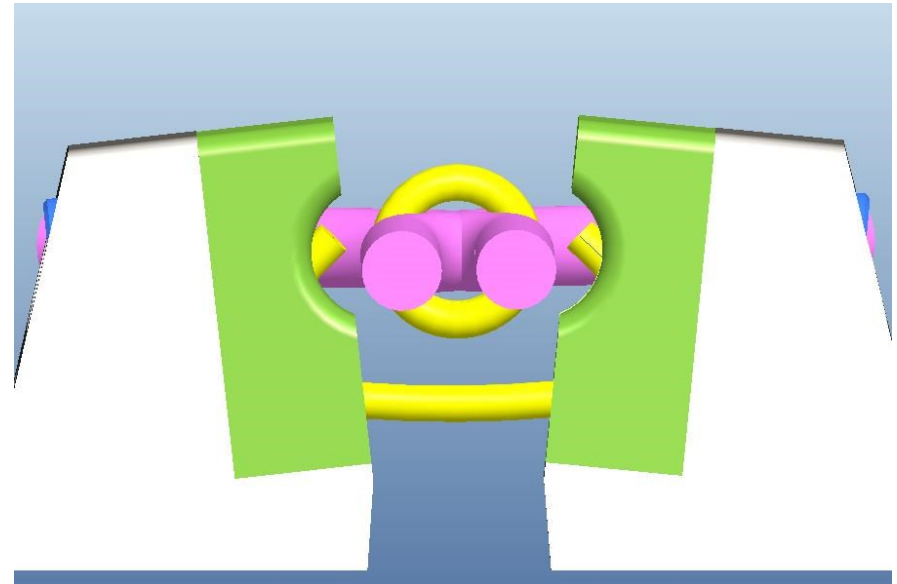
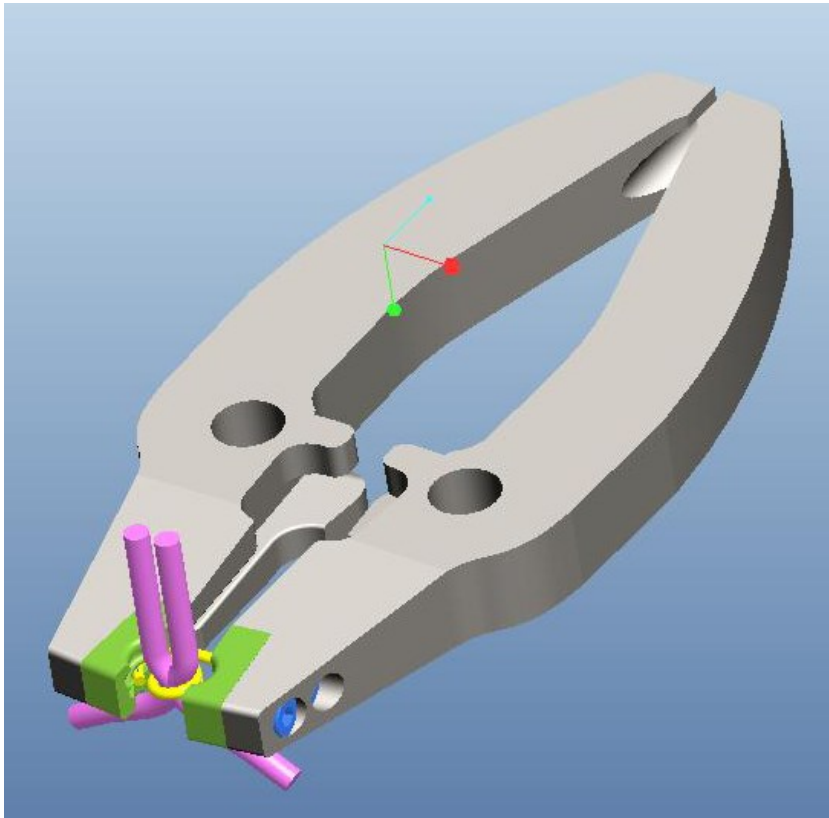
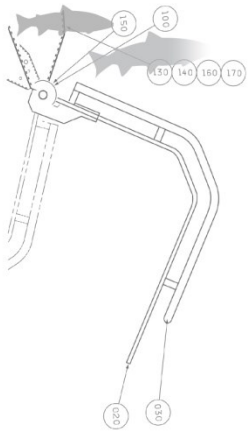

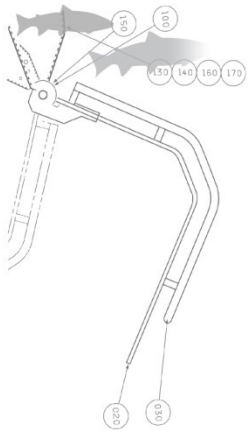

Utfordringer ved automatisering

- **Teknisk forståelse (bevissthet)**
- **Justere produksjonsrutiner**
- **Endre produksjons layout**
- **Redusert fleksibilitet**
- **Høyere stressfaktor**
- **Gjestearbeidere (språk)**
- **Service og vedlikehold**

Sperro produksjonsoppskrift

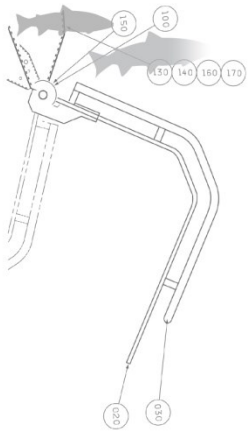

- **Produksjonsstørrelse: 600 tonn**
- **Sperro produsert: 500 tonn (1-7kg)**
- **Heldagsproduksjon**
- **2 operatører: 1 innmater / 1 tilrettelegger (veksler)**
- **Bulklaster + innmatingsbånd**
- **Normal dag => 1800 sperringer (12-16t)**
- **Lang dag => 2400 sperringer** (max reg. 2690sp => 21t)

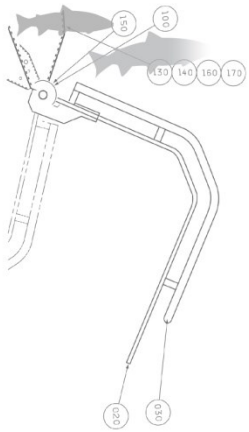

Takk for meg