

Prosjektstatus

Sperro

- litt historie
- status i dag
- bruker erfaring
- neste sesong
- utfordringer

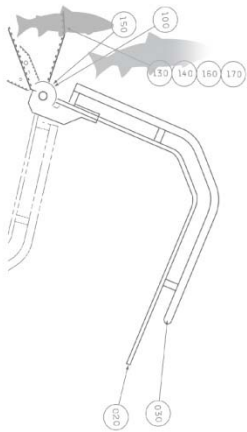



Litt om Sperro historien

2011

Jon Edvards
festesnor idé

Fungerte
ikke helt

Nytt prinsipp
testes på Røst

2012

Prototype test
på Røst

Produksjon
7 maskiner

7 uker på Røst
= 1 maskin

2013

Nytt verktøy
testes på Myre

Produksjon
nye verktøy

8 uker i V + L + R
= nesten 5 maskin

2014

Problemet i 2012?

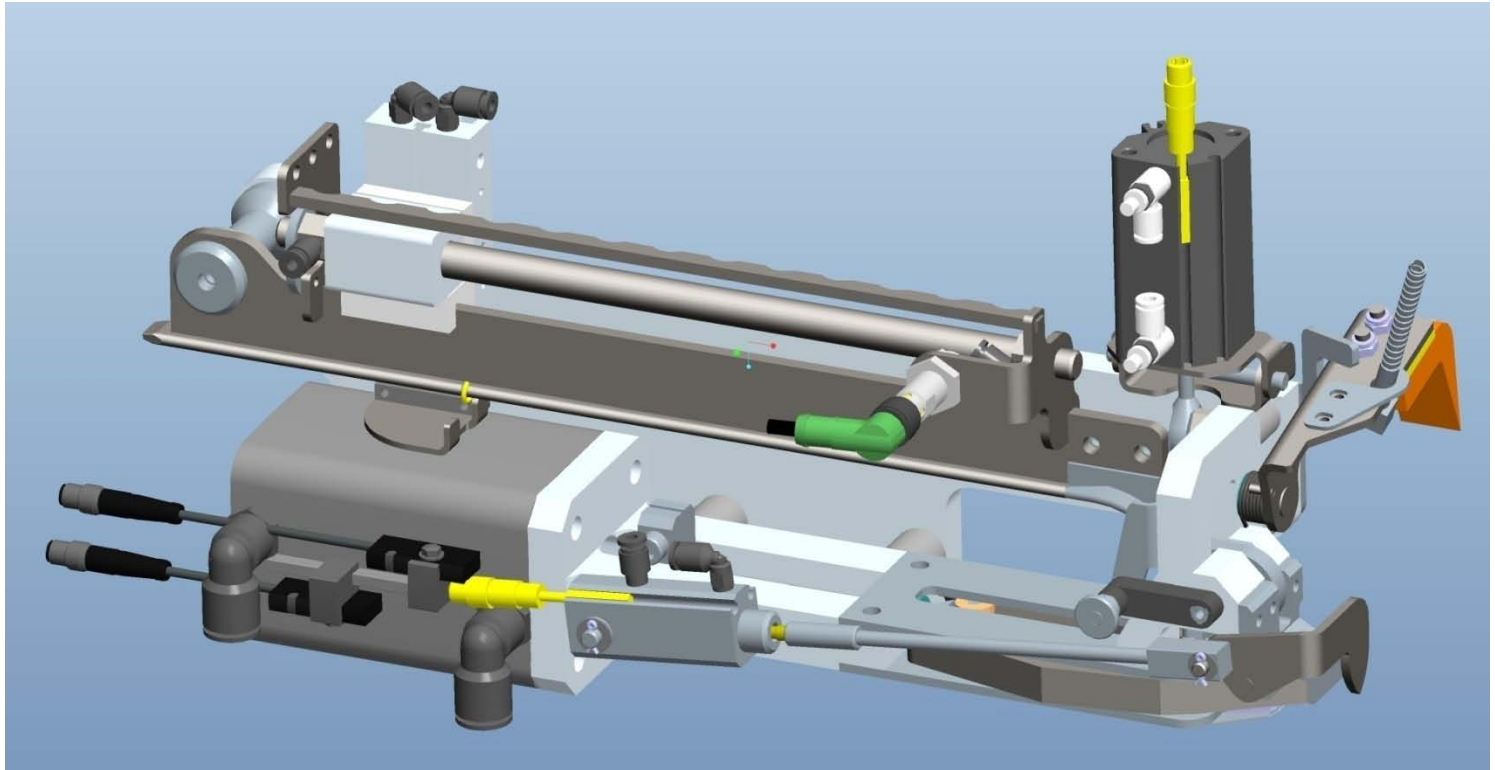
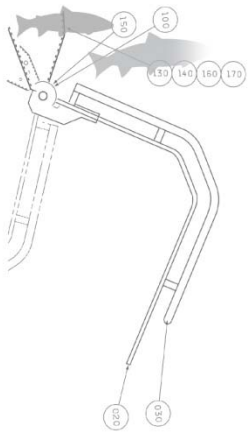

Problemene i verktøyet medførte feilbedømming av ringer og tau

Usikkerheter i 2013?

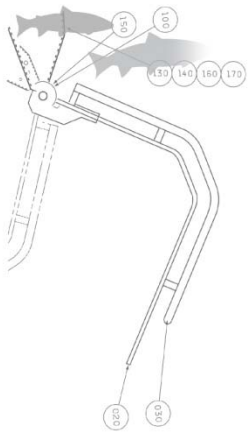

Det er mange
varianter av tau og
ringer der ute.
Noe kan brukes i
maskinen noe må
"kastes".

Hva skjedde denne sesongen?

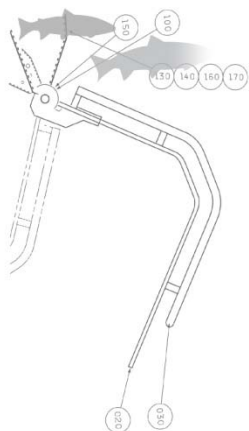



Mye kjøring mellom de 4 maskinen

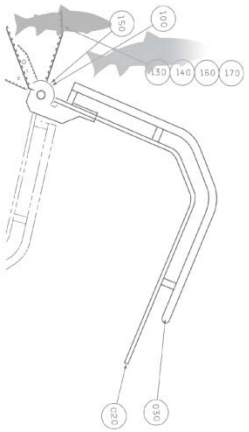

Hva var problemene denne sesongen?

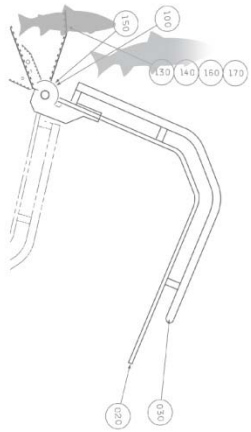

Det ble gjennomført ca 40 oppgradering, store og små detaljer gjennom sesongen.

- mindre maskinmontasje problemer
 - vanninntregning i plugger og kontakter
 - små justeringer i verktøy
 - noen sensor feil
-
- vask og sensorer er en utfordring
 - fjern diagnose er nødvendig
- Så dukket det opp slitasje problemer i klemkjeftene**

Slitasje på klemkjefter

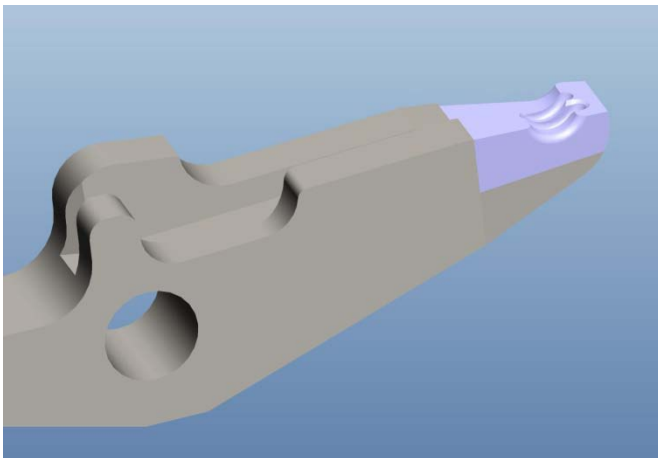
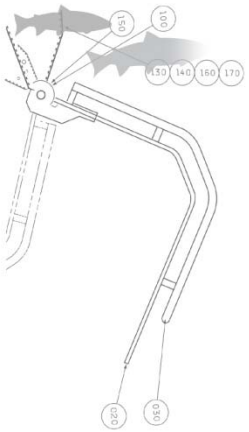

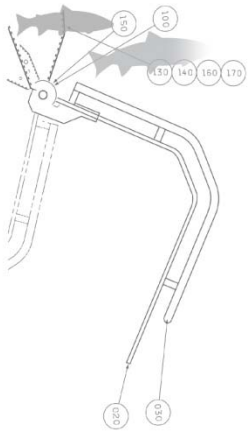

Bruker erfaringer



Frem til neste sesong

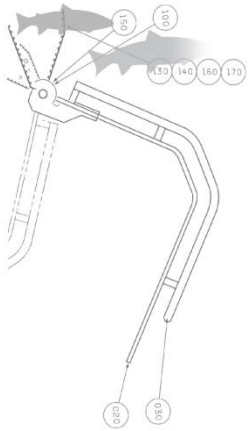

- oppgradering av de 2 siste maskiner på Røst
 - alle deler på lager
- nye klemkjefter på alle maskiner
 - må produseres
- produsere riktig tau med god fleksibilitet og knudrete overflate.
- vaskesikker sensorer kobling

Den store utfordringen

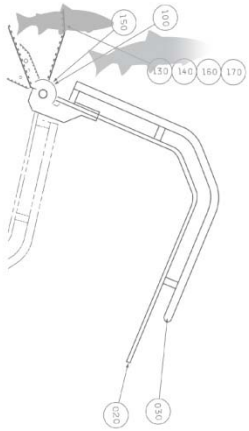

Oppgaven med å utvikle Sperro maskinen ble for kostbar og selskapet makter ikke å fullføre jobben uten en form for finansiell hjelp.

Prosjekt regnskap og prognose

Tilskudd: FHF/IN:	675'
Utviklingskostnader SFA	1.500' frem til 31.12.12
	1.200' frem til 31.12.13
	250' frem til 31.05.14
	300' frem til 31.12.14
	250' frem til 30.04.15
Sum utviklingskostnader	3.500' (7 serie)

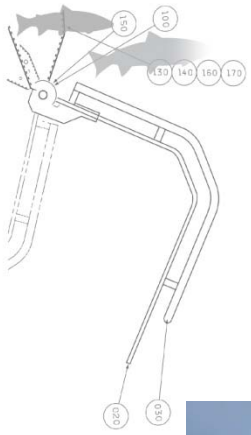

Et praktfullt syn

