

Report

Development and assessment of novel technologies improving the fishing operation and on board processing with respect to environmental impact and fish quality (DANTEQ)

Final Report

Authors

Ida Grong Aursand

Hanne Digre, Jarle Ladstein, Lars Tandle Kyllingstad, Ulf Erikson, Guro Møen Tveit, Christoph Backi, Karl-Johan Reite



Report

Development and assessment of novel technologies improving the fishing operation and on board processing with respect to environmental impact and fish quality (DANTEQ)

Final Report

DATE
2015-11-13**KEYWORDS:**Fisheries
Trawl
Whitefish
Electrical stunning
Chilling and freezing
CAS
Energy systems
Modelling**AUTHORS**

Ida Grong Aursand, Hanne Digre, Jarle Ladstein, Lars Tandle Kyllingstad, Ulf Erikson, Guro Møen Tveit, Christoph Backi, Karl-Johan Reite

CLIENT

The Norwegian Research Council

CLIENT'S REF.

199447/E50

PROJECT NO.

6020281

NUMBER OF PAGES/APPENDICES:

64

ABSTRACT

This is a final report of the project DANTEQ (2010-2015). Through this project new competence and new methods for optimal handling of whitefish onboard with respect to raw material quality and energy efficiency have been developed. The project was divided into four research areas; (1) catch handling, (2) chilling and freezing, (3) energy systems and (4) modelling. The main results are given below:

Short time live storage of fish before killing: When towing times are short and catches are small a survival of 50-80 % was found for cod (density of fish in the storage tank varied from 120 to 550 kg/m³). The fishing depth has influence on survival rate. The stress level of the fish was lower straight after catch than after storage in live holding tanks onboard (not always significant differences). Less blood was found in fillets from live stored fish and fish processed straight after catch compared to commercial processed fish.

Electro stunning of fish: Voltage of 40 V DC is enough to achieve satisfactory immobilizing and easier handling of catch in connection with further processing (bleeding/gutting/heading) for cod, haddock and saithe. Three rows of electrodes on the stunner (current load for 4 - 6 seconds) is enough to achieve satisfactory immobilization. Electro stunning of saithe lead to broken backbone and bloodspots on 10 to 40 % of the fish.

Freezing of cod: Pre-rigor cod frozen in a magnetic field (Cell Alive System) achieved minimal differences in quality compared to traditional tunnel freezing and freezing in a cold room, in spite of different freezing rates. The mechanism for freezing of fish in magnetic field appeared to be similar to that of traditional freezing methods.

Chilling of cod and haddock: Fish stored in slurry had a different microstructure and different water distribution, measured by low field NMR, than those stored in flake ice. Differences in colour and QIM-score were found for haddock stored under the two conditions.

Logging of operational data: Software for acquisition and storage of operational data has been developed. Systems for acquisition and storage of operational data, as well as transfer of the data to an on-shore server, have been installed on-board two trawlers. Software for efficient analysis of operational data has been developed and used to generate operational profiles.

Model development: Methods and models for simulating catch handling processes have been developed, along with proof-of-concept software that demonstrates their practical use. Discrete event simulation seems to be a very suitable method for simulating and evaluating fish processing lines, though more work needs to be done with regards to model quality and validation. Acquiring high-quality data about catch handling processes for modelling purposes is difficult and labour-intensive. Future experiments should be designed to focus more on individual processes and less on the whole line, and should aim to keep better track of the "human factors" that add noise and affect the outcome.

PREPARED BY

Ida Grong Aursand

SIGNATURE**CHECKED BY**

Tom Ståle Nordtvedt and Karl Gunnar Aarsæther

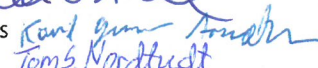
SIGNATURES**APPROVED BY**

Marit Aursand

SIGNATURE**REPORT NO.**

A27309

ISBN

978-82-14-06014-0

CLASSIFICATION

Unrestricted

CLASSIFICATION THIS PAGE

Unrestricted

Table of contents

1	Introduction	4
1.1	On board handling	4
1.2	Refrigeration technology	4
1.3	Energy systems	5
1.4	Model synthesis	5
2	Organization of the "DANTEQ" project	5
3	Project objective	5
4	Impact on Norwegian fisheries research, fish industry and the society in general	6
5	The project research areas and results.....	7
5.1	RA1: Optimized and automated on board handling of fish	7
5.2	Results of RA1: Optimized and automated on board handling of fish	8
5.2.1	Handling system for storage of live fish	8
5.2.2	Electrical stunning method for wild fish.....	10
5.3	RA2: Refrigeration technology and fish quality	12
5.4	Results of RA2	14
5.4.1	State of art: Novel chilling and freezing technologies relevant for the fishing fleet.....	14
5.4.2	LF NMR method and developement of customized data processing	17
5.4.3	Novel chilling and freezing technologies - effects on fish quality	21
5.5	RA3: Energy systems	23
5.6	Results of RA3	23
5.6.1	Overview.....	23
5.6.2	Data acquisition and storage	24
5.6.3	Data integrity	24
5.6.4	Operational profile	25
5.7	RA4: Model synthesis – fish quality and environmental impact	33
5.8	Results of RA4	36
5.8.1	Modelling and simulation methods.....	36
5.8.2	Gathering background data: The 2012 research cruise	39
5.8.3	Demonstration.....	50
5.8.4	Outlook	54
5.9	PhD thesis: Modeling, Estimation and Control of Freezing and Thawing Processes - Theory and Applications.....	55
5.10	Results of the PhD thesis	55
6	Conclusions	61
	References	62

Norwegian abstract

Bærekraftig høsting av villfanget fisk er en av de viktigste utfordringene i det globale bildet når det gjelder å skaffe tilstrekkelige mengder fisk. Det ligger et stort potensial i å høste fisk på en bedre måte. Norge er langt fremme både når det gjelder teknologisk utstyrsutvikling og anvendelse av nye fangstkonsepter, men det er fortsatt betydelige utfordringer spesielt i grensesnittet mellom den nye teknologien og fangstbehandling. Konvensjonelt fiskeri gjennomføres med flere forskjellige fartøykonsepter og redskapstyper. Felles for alle er at råstoffkvalitet og fangstinntekt henger sammen med fangst- og produksjonsprosess ombord med tilhørende investerings- og driftskostnader. Fiskefartøy har i langt større grad enn andre produksjonslokaliteter begrenset handlingsrom for å optimalisere prosessen med hensyn til økonomi og andre parametere som f.eks. miljøbelastning. Dette kommer i første rekke fra begrenset tilgjengelig volum og relativt kostbare tilgjengelige energikilder som f.eks. konvensjonelle oljedrevne motordrifter som benyttes til produksjon av elektrisk energi. Gjennom prosjektet DANTEQ har det blitt bygget ny kompetanse og utviklet metoder for å optimalisere håndtering av fisk ombord med hensyn til råstoffkvalitet og energieffektivitet. Arbeidet i DANTEQ har vært delt opp i fire ulike arbeidsområder (RA). Innen RA1 ble effekten av korttids levendelagring av fisk før slaktning og elektrobedøving studert. I RA2 var fokuset kjøle- og frysingsystemer ombord og effekt på råstoffkvalitet. I RA3 var fokuset å logge energiforbruk fra ulike kilder ombord på trålere for videre å kunne benytte disse dataene til energieffektiv drift av fiskefartøy. I RA4 ble det utviklet matematiske modeller og metoder for simulering av fangstbehandling og fabrikkprosesser ombord. Resultatene fra de ulike arbeidsområdene i prosjektet er oppsummert under.

- Korttidslevendelagring av fisk før avliving ga følgende resultater:
 - Ved korte tauetider og forholdsvis små fangster oppnår man en overlevelse på 50-80 % for torsk (tetthet i tanken varierte fra 120 til 550 kg/m³)
 - Fiskedybde har innvirkning på overlevelseshastighet.
 - Stressnivået i fisken så ut til å være lavere rett etter fangst enn etter lagring levende i tanken (ikke alltid signifikante forskjeller)
 - Det var noe mindre blod i filetene fra levendelagret fisk og fisk som ble bløgget rett etter fangst sammenlignet med kommersielt prosessert fisk.
- Elektrobedøving av fisk ga følgende resultater:
 - Spenning på 40 V DC er tilstrekkelig for å oppnå tilfredsstillende immobilisering og lettere håndtering i forbindelse med videre prosessering (bløgging/ sløying/ hodekapping) for hyse, torsk og sei.
 - Tre elektroderekker på bedøveren (strømbelastning i 4 - 6 sek) er tilstrekkelig for å oppnå tilfredsstillende immobilisering.
 - Elektrobedøving av sei førte til ryggknekk og bloduttredelser på mellom 10 og 40 % av fisken.
- Innfrysning av torsk gav følgende resultater:
 - Pre-rigor torsk frosset i magnetisk felt (Cell Alive System) gav minimale forskjeller i kvalitet sammenliknet med tradisjonell tunnelfrysing og frysing i fryserom til tross for ulik innfrysningshastighet.
 - Mekanismen for frysing i magnetisk felt så ut til å være de samme som for tradisjonell innfrysning.
- Kjøling av torsk og hyse ombord gav følgende resultater:
 - Slurrylagret torsk og hyse hadde ulik mikrostruktur sammenliknet med torsk og hyse lagret på flakis.
 - For hyse ble det funnet forskjeller i farge og QIM-score lagret på slurry og flakis.
- Logging av operasjonelle data ga følgende resultater:
 - Programvare for innsamling og lagring av operasjonelle data har blitt utviklet. System for logging av operasjonelle data har blitt installert ombord to trålere.
 - Programvare for effektiv analyse av operasjonelle data ble utviklet og brukt til å lage driftsprofiler.
- Modellutvikling ga følgende resultater:
 - Ulike simuleringsmetoder har blitt vurdert for simulering av fangstbehandlingsprosesser, og man har fokusert på bruk av *diskret-hendelsessimulering* som den best egnede metoden.
 - Matematiske/statistiske modeller for ulike fabrikkprosesser har blitt utviklet, bl.a. basert på målinger gjort ombord i fiskefartøy.
 - Det har blitt utviklet "proof of concept"-programvare som demonstrerer nevnte metoder og modeller i praksis, og som viser at simulering av prosesslinjer kan bli et nyttig verktøy i fremtiden.

1 Introduction

Fishing is an important economic activity in Norway. The annual catch rates between 1997 and 2007 were 2.2 - 2.9 mill tonnes. In comparison, the biggest producers within EU in terms of catch volume are Spain and Denmark, catching 0.71 and 0.87 mill. tonnes, respectively (Eurostat, 2006). The first-hand value of the Norwegian fisheries between 1997 and 2007 were 9 - 12 billion NOK, making Norway the 10th largest fisheries nation in the world in terms of wild fish production. Furthermore, Norway is the world's second largest nation in terms of export value, making seafood third of Norway's export articles.

In 2008, approx 12.900 people were full-time or part-time employed in the Norwegian fishing fleet. Additionally, a notable part of product categories like fishing vessels, gear equipment, on shore and land-based processing plants are made in Norway, contributing to significant spill-over effects in terms of industrial production through the entire infrastructure related to the fishing industry.

The sustainable yield in modern fisheries is limited by the stocks and quotas. However, there are still room for improvement within these restrictions. The most notable possibilities for such improvements are in reducing the environmental impact (consumption of fossil fuel) per kg caught fish and in safeguarding the initial fish quality, thereby increasing the part of the catch for human consumption. The Norwegian fishing fleet's most important challenge involves reducing operation costs, spill and emission while simultaneously maintaining a high utilization of the catch and an improved fish quality.

1.1 On board handling

In the latter years, the Norwegian fishing fleet has moved towards bigger vessels and increased capacity per vessel. Simultaneously the labour cost for fishermen has increased. Due to this, each fisherman must handle increased quantities of fish, and it poses a challenge both with respect to fish quality and safety. In addition, both national and international legislation focus more on animal health and welfare aspects in fish production. Once fish are captured and handled, some quality loss is inevitable. Nevertheless an unnecessary portion of the catch has reduced quality as a result of inadequate fishing gear and operation of the fishing gear, not efficient catch handling before bleeding/gutting, or bottlenecks in the on board handling systems. Crowding stress, pressure, various gear-related injuries etc, are all factors affecting time of premature death, and at a later stage reduced fillet quality. Often the cause of death is anoxia as the fish are left in air. Although not widely studied, it has been shown that catching methods and subsequent on board handling affect fish quality (Valdimarsson et al., 1984; Botta et al., 1987; Hattula et al., 1995; Esaiassen et al., 2004; Özyurt et al., 2007). Time before gutting has been shown to be more important than the bleeding/gutting methods (Botta *et al.*, 1986). Increasing catch quality gives better product prices, contributes to reduced discards, an increased part of the catch for human consumption and a more sustainable fishery. This is what the fishing companies in any case will be confronted with as the regulation (control) of fisheries constantly will be tightened throughout the world.

1.2 Refrigeration technology

Chilling along the processing chain immediately after catch and during storage is another important issue related to both fish quality and energy consumption on board a fishing vessel. In the latter years, new technologies such as CAS aiming at improving fish quality have been developed. However, the effects on quality are often not well documented, and, to help the industry making the right choices based on effects on quality and energy consumption in combination, there is a need to establish new knowledge on the area. Novel non-invasive measuring techniques such as low-field NMR combined with traditional analyses (water holding capacity, water activity and histology) have shown to be excellent tools for increasing the knowledge on quality effects of fish processing (Steen and Lambelet, 1997; Aursand et al, 2009).

1.3 Energy systems

A major challenge within the fisheries is the emission of climate gasses and particles. Norway has adopted international agreements, such as the Kyoto and the Gothenburg protocol (Norwegian Pollution Authority and Ministry of the Environment 2000), where Norway is committed to reduce the emissions of green-house gases, and fishing vessels has been selected as one area where the emissions should be reduced. In addition, the high energy consumption combined with increasing energy prices is causing profitability problems. So far ship-owners have met this challenge with modern machinery and propulsion system modifications while exhaust cleaning (e.g. catalyzers) and diesel-electric systems are seldom to find in fishing vessels yet. Promising new technologies exist, as well as a plethora of different energy components. The industry is, however, conservative, and is only slowly taking advantage of the possibilities herein.

1.4 Model synthesis

The onboard fish handling systems, refrigeration technology and energy systems are strongly interconnected, mainly because they compete for the same space and energy. The general energy systems may contain components which both produce and consume electric power, heat and mechanical energy, while the refrigeration and other catch handling systems are not likely to produce electric energy. Strong bindings may exist between the refrigeration and fish handling systems and the energy system of the fishing vessels in the form of electric and thermal energy. This could affect the quality of the fish, and improvements may be possible. One key question is how to ensure enough cooling capacity for peak loads without adding more machinery than necessary. To do this, the fluctuations in demands on the rest of the energy system must also be taken into account. The present project has developed methods, mathematical models and tools for simulating catch handling systems, taking into account their energy consumption and the effect on product quality and overall efficiency.

2 Organization of the "DANTEQ" project

RTD-partners

- SINTEF Fisheries and Aquaculture
- NTNU, Institutt for biologi
- NINA v/Carolyn Rosten

Industry partners

- Havfisk
- Eros
- Seaside
- Nordnes
- Nordic Wildfish (tidligere Roaldnes)
- Havyards MMC (tidligere MMC Kulde)
- Melbu Systems
- Wärtsila Norge

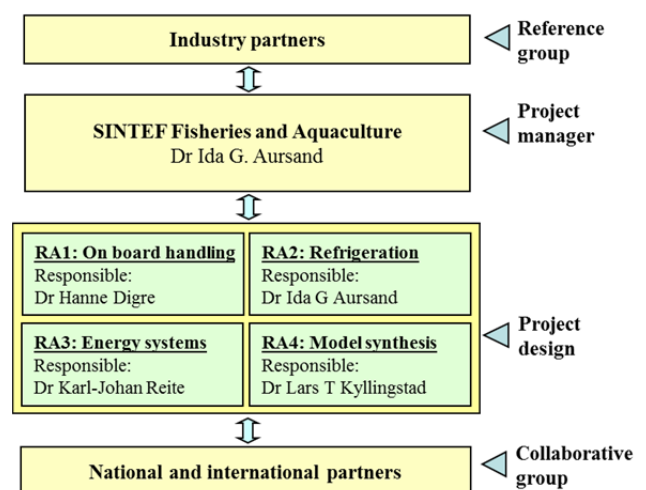

3 Project objective

Main objective: The main goal of this project is to improve the fishing vessel operation, energy system design and the on board fish processing with respect to fish quality and environmental impact.

The main goal is to be achieved through the fulfilment of several sub goals:

- 1) To develop novel on board automated catch handling systems safeguarding the initial fish quality as well as the fishermen's HSE (Health, Security and Environment).

- 2) To improve refrigeration onboard a fishing vessel with regard to fish quality, installed equipment capacity, space requirement etc. and energy consumption.
- 3) To provide the foundation for quantitative analysis of the on-board machinery and energy systems for a fishing vessel defined by its operational profile (including refrigeration and handling system loads) and physical parameters.

The sub goals 1-3 are inherently interconnected, as they compete for the same resources, such as energy and space. Improvements in one area may easily degrade the performance in others, and regarding these areas as separate systems may easily lead to sub optimization. This project will therefore aim to develop a unified system model, allowing the effect of one change to the total system to be predicted. This includes collecting and coupling the models developed in the project into one unified model.

4 Impact on Norwegian fisheries research, fish industry and the society in general

- The time from capture to bleeding is an important factor in order to improve flesh color of wild caught fish. Short time storage (maximum a few hours) of live fish before killing will prolong the time which is available to process the fish before it is dead. Therefore, short time storage of live fish will improve the degree of bleeding. However, introducing live-storage concept leads to major costs and challenges for today's production process on board the trawlers, and therefore more research is needed before we can conclude.
- Electrical stunner for whitefish is implemented onboard several national and international fishing vessels today. Electro stunning of wild fish enables faster processing of fish after harvest, which improves the bleeding degree. The electro stunner also improves safety conditions for fishermen as the fish is calm and easier to handle after stunning.
- Optimal freezing and frozen storage is important to maintain high quality. High freezing rates do not seem to be critical unless they are very slow. However, there may be other reasons to prefer high freezing rates such as factors related to processing line speed and capacity. By using available technology for freezing of fish in weak magnetic fields, no improvements were observed as compared with fish frozen by using traditional freezers. The results from this project shows that today's method is good.
- Chilling by use of slurry ice may be an alternative to traditional flake ice. It may be easier to handle than traditional flake ice. However, some differences in quality (colour, QIM, microstructure and water distribution in the muscle tissue) may occur.
- A system for continuous acquisition of operational data has been developed and installed on-board two trawlers. Acquisition of operational data can form the basis for development of models for energy systems on-board as well as provide information on the operations of the vessel in practical fisheries. Together, this can be used both to improve the design of energy systems of new vessels and as a basis for operational decision support systems on-board. Both of these applications can result in more energy efficient fisheries and lowered emission of climate gasses.
- Methods, models and tools for simulating catch handling processes—specifically, the on-board factory and refrigeration systems—have been developed. In the future, these could be used during vessel and factory design to optimise the catch handling systems, resulting in higher product quality, improved processing efficiency, lower energy consumption and reduced costs.

5 The project research areas and results

The research was run through four research areas as shown in Figure 1.

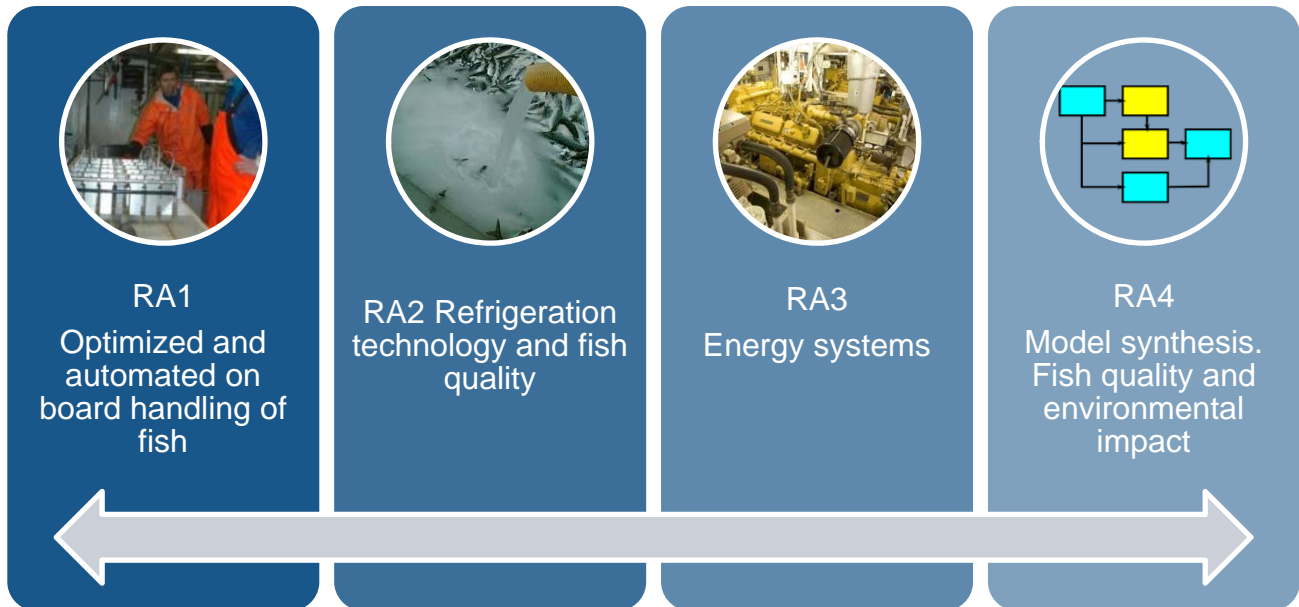

Figure 1: Research activities in the Danteq project.

5.1 RA1: Optimized and automated on board handling of fish

Background

Wild caught fish have always suffered under an almost inherent loss of quality caused by the fishing gear itself, inappropriate operation of the fishing gear, not efficient catch handling before bleeding/gutting and bottlenecks in the on board handling systems. The ultimate goal is to bring the fish on board alive and keep it alive until bled and gutted. However, a prerequisite for more alive fish on board are gentle and efficient capture and first handling. Due to often unforeseen large catches, especially in the trawling and purse seining fisheries, there are problems with keeping fish alive in the period between transfer from sea until it is bled and gutted. New systems, as live holding tanks, to prevent irreparable quality degrading in the period between transfer from sea until it is bled and gutted will be evaluated by case studies on board. In order to obtain optimal quality in the fillet, the fish have to be bled and gutted immediately after capture. In an earlier project “*Catch handling on board big Danish seine vessels*” done by SINTEF and Fiskeriforskning the time between catch (when the fish is landed on board) and bleeding/gutting is critically for the bleeding of fish (Akse et al., 2005). The bleeding/gutting procedures have to be done within 30 minutes after the fish are dead, which today is difficult/impossible to fulfil with existing technology and routines.

Automated stunning of alive catch will allow more rapid bleeding, gutting and rinsing of the fish. Electrical stunning has been identified as a fast and efficient method to render fish unconscious and insensible (Robb & Roth 2003; Lambooij et al., 2004). However, injuries like fractures of the vertebrae and rupture of dorsal arteries may occur in electrically stunned fish (Roth, 2003). These injuries are not acceptable commercially as blood spots and haemorrhages in the fillets will reduce the market value. However, Digre *et al.* (2009) concluded that electrical stunning of Atlantic cod did not affect the flesh quality. Experiments performed by SINTEF with on board electrical stunning of cod caught by trawl indicate also that this treatment allow more rapid gutting and rinsing of cod without negative quality effects from the electrostunner itself (project 179419/Matprogrammet: “*Superfersk fisk med riktig kvalitet*”). Automated on board stunning of alive catch combined with direct gutting and bleeding could increase the fish quality and at the same time safeguard

HSE for the fishermen. In this project, a development and verification of equipment and operating procedures for an electro stunner tailor made for wild fish of varying size and species will be performed.

SINTEF F&A is and has been involved in several project related to catch and on board handling, which this project will be linked: BIP - Automatisk avliving av laks (2007-2010), BIP - Elektrobedøving av oppdrettstorsk i kommersiell skala (2009-2010), Fangstbehandling i snurrevadflåten (2009), Superfersk fisk med riktig kvalitet (2007-2009), Establishing a standarized, ethical slaughter line for farmed Atlantic cod (2005-2007), Produkter og foredlingsprosess i havfiskeflåten. Nye teknologiske muligheter og driftsøkonomiske virkninger (2005 -2007), “Pelagic quality from sea to dish”, (2003-2008), Forholdet mellom redskap og kvalitet på fisk, råstoffbehandling ombord i fartøy (2003-2005).

Tasks

T1.1: *Handling system for storage of live fish*

As a general observation critical factors influencing the quality during catching and on board handling for the targeted species (cod, haddock and saithe) will be identified and included in this task. Fish caught by either trawl or Danish seine will be used in the practical experiments on board. Different kind of handling system for holding live fish on board can be used e.g. a water-filled holding tank on board, floating cages and wells. Holding tanks can be equipped with oxygen control, water filtering and circulation and temperature control. The possibility of fish recovery in the tank will be evaluated. These studies will be coordinated with the ongoing project regarding catch based aquaculture (Teknologiutvikling for fangst, håndtering og føring av levende villfisk, FHF, 2009). Fish behaviour, handling stress, possible damages and (delayed) mortalities will be assessed. The catch will then be stunned according to T2.2. In this task the main activities will comprise:

- Evaluate present lay-out and design for keeping fish alive from established knowledge in catch based aquaculture and salmon (live) carrier boats
- Design an optimal system for storage of wild caught fish

T1.2: *Electrical stunning method for wild fish*

Different fish species, mainly cod, haddock and saithe, will be taken from (a) the current storage method for fish on the vessel and (b) by using fish from the holding tanks for live fish (T2.1) and electrical stunned using a prototype electrical stunner developed by SeaSide. Development and verification of equipment and operating procedures tailor made for electrical stunning of wild fish of varying size and species will be performed. Fish behaviour will be assessed during stunning. After each fish is stunned and killed, flesh quality will be assessed with a special focus on visual appearance in the fillets like; blood spots, discoloured areas, residual blood and spine affected. In addition white muscle-pH, muscle twitches, body temperature, weight, length, appearance (skin etc) will be measured. Fish will be placed on ice for rigor assessments and quality assessments after storage. Machine vision will be used as a tool for an objective measurement of fish quality. Some of the advantages of using machine vision for quality control in this projects are: The ability to determine and quantify the colours present in a sample, to quantify bleeding and blood spots, to provide a permanent record by keeping the picture, to be able to detect 2D/3D shape and size of the product, and to be able to detect defects and deformation that decrease the quality of products.

5.2 Results of RA1: Optimized and automated on board handling of fish

5.2.1 Handling system for storage of live fish

The concept of introducing live-storage tanks on board to prevent poor bleed-out has been studied in this task. The fish species included in the study has been haddock and cod caught by trawl. Two experiments have been conducted where the main aim have been to compare short term live storage (sampling times 0, 1.5, 3 and 6 h) before slaughter with commercial processing procedures (storage without water) and the impact on fish quality (blood residuals), see Figure 2. The experiments are reported in the two publications listen below.

Capture can affect the fish in terms of damages, stress and product quality. Gear damages can be associated with compromised welfare as well as inferior product quality (See e.g. Esaiassen et al., 2004; Digre et al., 2010; Rotabakk et al., 2011; Olsen et al., 2014). The ultimate goal is to bring the fish on board alive and keep it alive until bled and gutted. It has been showed that immediate bleeding of the catch just after capture will avoid poor bleed-out of the catch (Kelly, 1969; Huss and Asenjo, 1976; Valdimarson et al., 1984; Botta et al., 1986; Olsen et al., 2014). However, a prerequisite for more alive fish on board are gentle and efficient capture and first handling. Due to often unforeseen large catches, especially in the trawling and purse seining fisheries, there are problems with keeping fish alive in the period between transfer from sea until it is bled and gutted.

New systems, as live holding tanks, to prevent irreparable quality degrading in the period between transfer from sea until it is bled and gutted have been focused in this work. Short-term holding of fish within fisheries prior to slaughter can present a number of welfare considerations related to the condition of the fish after capture. Welfare standards must be maintained for short-term holding to be a feasible option for the industry.



Figure 2 Short term storage of live cod caught by trawl on board RV Helmer Hansen in 2014 (Photo by SINTEF).

Publication I:

Digre H, Rosten C, Erikson U, Mathiassen JR, Aursand IG (2016). *Short period live storage of trawl caught cod (*Gadus morhua*) and haddock (*Melanogrammus aeglefinus*) and the effect on fish behaviour, mortality, handling stress and fillet quality (I). Submit to Fisheries Research Dec.2015*

Authors: Hanne Digre, Carolyn Rosten, Ulf Erikson, John Reidar Mathiassen, Ida Grong Aursand

Title: *Short period live storage of trawl caught cod (*Gadus morhua*) and haddock (*Melanogrammus aeglefinus*) and the effect on fish behaviour, mortality, handling stress and fillet quality (I)*

Abstract:

The aim of the study was to compare immediately processed fish (0 h), short term live storage (sampling times 1.5, 3 and 6 h) before slaughter with commercial processing procedures (storage without water) and the impact on fish quality (blood residuals). Additionally, fish behavior during live storage was observed, mortality and the effect of handling stress was assessed by quantifying the changes in several blood constituents, initial white muscle pH, twitches and rigor onset. Fillet color in the CIE L*a*b* color space, and presence of discolorations by Fillet Index method were employed on fresh (on board) fillets.

The results showed that fish hauled from about 70 m showed reduced stress behavior and a higher survival rate (80-95 %) compared to fish hauled from about 300 m (survival rate 50-70%). Live stored fish exhibited somewhat elevated levels of some of the blood constituents as cortisol, glucose and lactate for both haddock and cod compared to fish killed immediate after harvest. The fish were stressed by capture. Delayed bleeding

(storage of fish in air for about 5 h), resulted in fillets with significant higher total fillet score, indicating higher degree of discolorations in the fillets compared to the other treatments.

Publication II:

Erikson U, Digre H, Tveit GM, Øye ER, Aursand IG (2016). *On board live storage of trawl-caught cod (Gadus morhua) as a concept for minimizing residual blood in fillets (II). Submit to Fisheries Research Dec.2015*

Authors: Ulf Erikson, Hanne Digre, Guro Møen Tveit, Elling Ruud Øye, Ida Grong Aursand

Title: *On board live storage of trawl-caught cod (Gadus morhua) as a concept for minimizing residual blood in fillets (II).*

Abstract:

Delayed catch handling on board trawlers can result in discolouration of Atlantic cod fillets. The concept of introducing live-storage tanks on board to prevent poor bleed-out was studied. The condition of the fish was determined (blood pH, lactate, glucose, and initial white muscle pH, twitches and rigor onset) after the trawl gear was hauled on deck. Fillet colour in the CIE L*a*b* colour space, and presence of discolorations by Fillet Index and fillet ranking, were employed on fresh (on board) and frozen/thawed fillets (market quality). The fish were considerably stressed by capture. When cod were bled immediately after capture, or after live storage for 3h and 6 h, good fillet quality can be achieved without serious discolorations. Delayed bleeding (storage of fish in air for 5 h), clearly resulted in fillets with inferior colour characteristics. The colour characteristics of fillets evaluated on board (after bleeding) and after frozen storage (market quality) were basically similar. The practical implications of the findings were discussed.

5.2.2 Electrical stunning method for wild fish

Electrical stunning of trawl caught cod, haddock and saithe have been studied in this work. Several experiments have been conducted and 3 papers will be published. For more than a decade, much focus has been put in the aquaculture industry to improve stunning and killing methods of several fish species. The main driving force has been to improve fish welfare by rendering the fish instantly unconscious (or dead) so that the fish can be killed without any sensation of pain. For wild fish, the industry and government, perhaps for practical and economic reasons, has not yet prioritized animal welfare.

To facilitate immediate bleeding after capture electrical stunners are being introduced on larger vessels. The goal has been to render the fish immobilized which can be achieved at a relative low stunning voltage. In other words, no focus has been put on immediate stunning to induce unconsciousness, as is required by legislation in the aquaculture industry.

In this work we have found that electrical stunning can lead to broken spines and bloodspots in fillets of some fish species such as saithe (*Pollachius virens*). Under the same electrical conditions, however, cod (*Gadus morhua*) and haddock (*Melanogrammus aeglefinus*) can be stunned without the occurrence of broken spines and bloodspotting. The results from these studies are reported in the papers listed below. Figure 3 shows electrical stunning of cod.

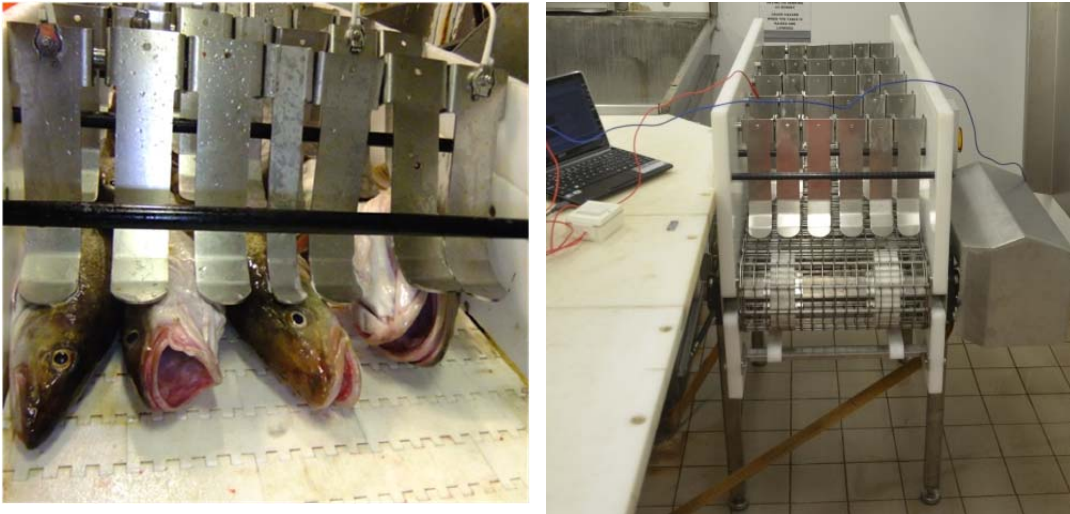

Figure 3: Electrical stunning of cod using STANSAS #1, a commercial dry stunner from SeaSide AS (Stranda, Norway). (Photo by SINTEF).

Publication I:

Lambooij B, Digre H, Reimert HGM, Aursand IG, Grimsmo, L, van de Vis H. (2012). *Effects of on-board storage and electrical stunning of wild cod (*Gadus morhua*) and haddock (*Melanogrammus aeglefinus*) on brain and heart activity. Fisheries Research, 127-128: 1-8.*

Authors: Lambooij B, Digre H, Reimert HGM, Aursand IG, Grimsmo, L, van de Vis H.

Title: Effects of on-board storage and electrical stunning of wild cod (*Gadus morhua*) and haddock (*Melanogrammus aeglefinus*) on brain and heart activity.

Abstract:

Cod and haddock captured with commercial trawling gear were taken immediately after landing on deck to on-board storage in dry bins for measuring brain and heart activity, and behaviour. Other groups were first stored in holding tanks and then electrically stunned with a prototype “dry stunner”. For stunning 52 Vrms was applied on individual fish for 1 s. As a result, the cod and haddock received an electrical current of 0.34 ± 0.09 and 0.36 ± 0.12 Arms, respectively. Electrical activity in the brain and heart was measured before and after electrical stunning. The fish remained conscious for at least 2 h after landing and during on-board storage as indicated by the electrical activity measured in brain and heart. Behavioural responsiveness to administered stimuli was absent in both species. After electrical stunning, both species showed a general epileptiform insult which was characterised by a tonic phase followed by a clonic phase and terminating with an exhaustion phase. Since the fish remained conscious after landing and storage, electrical stunning and subsequent killing with a throat cut, may provide an option for improving fish welfare on-board commercial fishing vessels. In particular, we recommend to stun and kill wild cod and haddock as soon as possible after landing on deck using a dry stunner applying 52 Vrms (coupled AC/DC current) for more than 3s.

Publication II:

Erikson, U., Digre, H., Grimsmo, L (2015). *Electrical immobilisation of saithe (*Pollachius virens*): Effects of pre-stunning stress, applied voltage and stunner configuration. Submitted to Fisheries Research December 2014.*

Authors: Erikson, U., Digre, H., Grimsmo, L

Title: Electrical immobilisation of saithe (*Pollachius virens*): Effects of pre-stunning stress, applied voltage, and stunner configuration

Abstract:

Electrical stunners have been introduced on some Scottish seiners in Norway to facilitate easier handling of fish in connection with the bleeding operation. Evaluation of stunning efficiency of Atlantic cod, haddock and saithe at sea has been successful for cod and haddock. In contrast, electrical stunning of saithe can result

in broken spines and blood spots for a certain fraction of a catch. A controlled experiment was therefore carried out with saithe where the goal was to minimize the detrimental effects of electrical immobilisation. Since two configurations of the electrical stunner are in use on different vessels, we studied stunner configuration along with electrical stunning voltage (40, 70 and 100 V) as variables. In addition, we hypothesized that post-capture remaining energy for contraction of white muscle (reflecting pre-stunning stress) stimulated by electricity could be a factor to consider related to the occurrence of spinal fractures. Fish behaviour, eye-roll (VOR), and recovery time were used as indices of stunning efficiency. Effects of stress on white muscle were assessed by changes in initial pH, twitch ability, and blood lactate levels. The results showed that regardless of pre-immobilisation stress level, stunner configuration, and voltage, all fish responded instantly upon exposure to electricity. Absence of VOR indicated that the fish were unconscious as assessed immediately after immobilisation. However, after 10 min of recovery in seawater, many fish in all experimental groups regained consciousness. Compared with rested fish (control), blood lactate, white muscle initial pH and twitch ability were affected by pre-immobilisation stress and subsequent fish handling procedures. Neither stunner configuration nor applied voltage fully solved the problem with spinal fractures and blood spots in saithe. To minimize the problem though, the current research showed that the best stunner configuration was to use the conveyor belt as counter electrode rather than using alternating charge on adjacent rows of electrodes. Furthermore, stunning of fish subjected to pre-immobilisation stress also reduced the probability for spinal fractures and blood spots. More research is nevertheless necessary to eradicate the problem altogether.

Publication III:

Digre H, Aursand IG, Tveit GM, Erikson U, Grimsmo L, Lambooij B, van de Vis H. (2016). *Effects of live holding and electrical stunning of trawl caught cod (Gadus morhua) and haddock (Melanogrammus aeglefinus) with respect to stress. Submit to Fisheries Research Dec.2015*

Authors: Digre H, Aursand IG, Tveit GM, Erikson U, Grimsmo L, Lambooij B, van de Vis H.

Title: Effects of live holding and electrical stunning of trawl caught cod (*Gadus morhua*) and haddock (*Melanogrammus aeglefinus*) with respect to stress.

Abstract:

The aim of this research was to study electrical stunning of cod, haddock and saithe, and its effect on fish welfare, stress and quality. The electrical stunner used was a prototype developed by the Norwegian equipment vendor SeaSide AS. For stunning, different voltage has been used (20, 40, 50, 70, 100 V) on individual cod, haddock or saithe for 1-7 sec. After electrical stunning, the fish were observed in a water-filled tank for 10 min to observe potential recovery. Different stress and quality parameters were measured. The fish analyzed were taken from; a) current storage method for fish on the vessel (in dry bins); b) current storage method onboard (in dry bins) followed by electrical stunning; c) holding tanks for live fish followed by electrical stunning. The results show that electrical stunning is a promising method for stunning of the catch. A throat cut 30 sec post stunning can be a suitable method for killing of electrically stunned cod and haddock, as no recovery occurs. However, there are challenges related to the electrical stunning of saithe that needs to be solved, namely broken vertebrae and ruptured blood vessels.

5.3 RA2: Refrigeration technology and fish quality

The capacity of refrigeration and/or the choice of freezing technology influences both the product quality and the power demand. Therefore, a multidisciplinary approach is of importance to optimize processes. To maintain a high quality product achieved by an optimal catch handling (covered in RA1) a good chilling/freezing regime is highly important. Lowering the temperature of fish products retards the demolishing biochemical and physical processes acting after the death occurs. Heat transfer rate as well as thermo-mechanical (internal pressure during freezing) and electro-magnetic conditions during processing and storage may affect the resulting product quality in varying ways. During the fish freezing process, free water is transformed into ice crystals which cause mechanical damage to the muscle cell structure (Bello et

al, 1981). Furthermore, frozen storage also gives rise to protein denaturation. As the structure of the fish meat is altered, properties including especially water holding capacity, which have an impact on final product quality in terms of juiciness, texture, yield etc., are altered. In that way, the capacity of refrigeration and the choice of freezing technology influences both the *product quality* and the *power demand*, which both are issues of high importance for the Norwegian fish fleet.

Several novel refrigeration technologies have been introduced in the past few years to improve the quality of the product. The most beneficial use of new chilling/freezing technologies requires development of advanced engineering methods and tools as well as an increased knowledge of how fish quality is affected by such technologies. Various novel chilling/freezing technologies such as CAS (Cells Alive System) have been taken into use in Japanese fishing vessels. However, more knowledge on the effects on both fish quality and energy consumption of integrating such equipment on board is still essential to make the fish fleet capable of making the right choices. In this RA, new chilling/freezing possibilities will be identified. In addition to CAS-freezing of white fish on board (an parallel activity for on-land freezing of salmon, FHF project no. 900275), we wish to study methods of establishing subzero temperature above but close to initial freezing point, avoiding the partial freezing, texture changes and increased drip loss associated with the so-called super-chilling process. A third example is quantifying the quality effect of external pressure during freezing as experienced in the commonly used plate freezers. The increased interest for low temperature freezing using CO₂ as refrigerant and a Freon-replacement actualizes the study of the thermo-mechanical stresses.

Experiments will be conducted to assess how the quality of the product is affected. The quality effects will be investigated using a combination of *novel measuring techniques* such as low-field 1H NMR (nuclear magnetic resonance) and light microscopy. Low-field NMR has shown to be a fast and powerful method that can be used for non-invasive determination of water mobility changes due to raw material quality and processing (Aursand, 2009; Matforsk-SINTEF SIP, NRC project no. 153381/140). The application of low-field NMR to fish and fish products opens up a possibility to relate the state and dynamics of water to various technological parameters. This makes it a unique tool in the study of changes in product quality as affected by freezing and/or chilling. A few LF NMR studies on frozen stored fish have been conducted (Steen and Lambelet 1997; Aursand et al, 2009). However, these studies have focused on traditional freezing technologies. In this project, models for the relation between the water properties in the muscle tissue due to choice of freezing/chilling technology and procedure will be established based on a combination of measuring techniques.

Tasks

T2.1: Identification of novel chilling/freezing technologies relevant for the fishing fleet – state of the art

Different new novel chilling and freezing technologies will be identified. Investment costs, operating costs and technical possibilities for on board implementation will be evaluated.

T2.2: Choice of LF NMR method and development of customized data processing

Pre-studies will be done to find the best LF NMR methods for detecting changes in tissue water due to chilling/freezing and customized data processing tools will be developed to analyze NMR data and combine the results with traditional methods. The data processing tools will be used to detect and identify fish quality effects on the choice of chilling/freezing technology.

T2.3: Investigations of novel chilling/freezing technology on fish quality

- a) The internal pressure in whole gutted fish during freezing by different technologies. The effect on structure and water binding capacity of the fish muscle after thawing will be studied.
- b) NMR, micro-structural analysis and traditional physicochemical methods will be used to assess fish quality by use of different chilling/freezing technologies. CAS will be compared with more traditional chilling/and freezing technology. The work in this task will be case oriented.

5.4 Results of RA2

5.4.1 State of art: Novel chilling and freezing technologies relevant for the fishing fleet

One of the goals of this work area was to evaluate the effect of two different freezing/chilling-methods on wild fish quality. Important aspects were to find technologies that were suitable for fishing vessels. Important factors to consider in this context are the presence of a corrosive environment, freezing capacity, hardware investment and operating costs. In addition, the technology should be the environmental friendly.

A lot of research have been performed on the freezing of fish. Only the main aspects are summarized in this chapter. The focus of this study have been mainly on freezing methods, and especially on new promising freezing methods suitable for fish. Independent of cooling medium and method for heat transfer, different freezing methods may be categorized either as mechanical or cryogenic, or combinations of these two (Bejarano Wallens & Venetucci, 1995). A good freezing method implies that the critical temperature zone (-1 til -5 °C) is passed by as fast as possible, preferably within a few hours. Most freezers that are used in the fishing industry can manage this within 2-3 hours. Most of the aspects regarding freezing of fish and choice of method are covered by Kolbe & Kramer (2007). When fish are frozen pre-rigor most of the water is located within cells. The ice crystals will then be formed inside the cells. When fish are frozen in rigor or post rigor, a considerable part of the water will freeze outside cells (extracellular), which may lead to damages on membranes and other structures, especially during slow freezing. The quality of fish products is not dramatically influenced by freezing rate except in cases where the freezing rate is very slow freezing such as when freezing occurs during a 24-hour period or more (Anonym, 1977; Kolbe & Kramer, 2007).

Freezing under high pressure

Freezing under high pressure (HP) represents an interesting technique where pressure and temperature can be varied to affect the quality of a product after thawing. In food processing, the technique has been studied since the start of the 1990's (LeBail et al., 2002). High pressure freezing may in principle be used in two different ways, namely as 'HP shift freezing' and 'HP assisted freezing'. When comparing the two, 'HP shift freezing' was found to be the best method (Fernández et al., 2006). Thawing under high pressure is in itself a method that may improve the thawing process. Typical applied pressures for high pressure processing (HPP) are 150-700 MPa. A lot of research on different fish species have been performed, and several favorable effects have been found. Also, some disadvantages have been identified. In a review-paper on HPP of fish and fish products, Ohshima et al. (1993) concluded that the treatment causes (partly) inhibition of microbial activity and some endogenous enzyme systems. The treatment may also lead to protein denaturation and accelerate lipid oxidation in muscle tissue.

Li & Sun (2002) evaluated potential new freezing and thawing methods for rapid freezing of foods. The following freezing methods were evaluated: HP freezing, partly dehydration before freezing, and use of proteins as antifreeze compound. The following methods for rapid thawing were evaluated: HP, microwaves, electrical resistance ('ohmic') and acoustic (ultrasound) thawing. The most important advantage with HP freezing was that the initial formation of ice was instantaneous and homogenous through the whole products due to the supercooling effect induced by the pressure shift. This resulted in a lower degree of freezing damages in the product. The phase diagram (temperature versus pressure) for water and ice showing the different phases gives a good image of the various possibilities that can be achieved by HP freezing (see Li & Sun, 2002). It is possible to supercool a product without actually freezing it. Fish may be held in a fresh condition on at for example -15°C without formation of ice (HP-storage). By increasing the pressure further, one may achieve a higher density of the ice (type V and VI), which in turn will lead to less damages to the product (Kalichevsky et al., 1995). In this way, the microstructure of the product will be less damaged compared to applying traditional freezing. Furthermore, it is possible to freeze a product by applying pressure of higher than 600-700 MPa without any cooling.

The following advantages have been identified by HPP of salmon fillets: partial reduction of bacterial counts, lower drip losses, and reduced thawing times (Alizadeh et al., 2007). Smaller and more regular ice

crystals were achieved by the use of 'Pressure-Shift Freezing' (PSF), which may lead to a higher degree of preservation of original microstructure, which means less freezing damages of the product. Fillet color was affected by the PSF-treatment, among other factors, significantly higher CIE L*-values (lightness) have been reported. These experiments were performed in a pressure chamber with maximum capacity 3.5 liters, at a pressure of 200 MPa, temperature of -18°C and by a rapid drop in pressure (10 sec). 'Pressure-Assisted Thawing' (PAT) was studied at 200 MPa and 20°C. Under these conditions, the thawing time was only 14 min (Alizadeh et al., 2007). The hardness of salmon fillets increased by use of PSF compared to traditional freezing methods, possibly due to protein denaturation. Increased hardness of turbot fillets after treatments at 140 MPa and -14°C (Chevalier et al., 2000a) and lobster at 200 MPa and -18°C (Chevalier et al. 2000b) has also been reported. Denaturation of myosin was observed in cod muscle after using pressures of 100-200 MPa (Angsupanich & Ledward, 1998).

Small production volumes (typical volumes of pressure chambers in HP-equipments are 0.15 mL to 3000 mL) and high costs are reasons that explain why HP-equipment so far is almost nonexistent in the food industry (Leygonie et al., 2012). A high degree of precision is also needed when applying HP. Furthermore, in an unstable, corrosive environment such as on board fishing vessels, the method does not seem to be of current interest.

Freezing in a weak magnetic field - The Cell Alive System

The CAS (Cell Alive System) technology, developed in Japan, was assessed in the current project. The method is marketed as the preferred method to freeze live cells (plants, vegetables, meat and fish) in order to maintain their original fresh appearance and structure. The principle is based on that fresh products (live cells) is frozen in a weak magnetic field. The CAS study is reported in the following chapter. Our conclusion was that fish quality did not differ from that obtained by traditional freezing methods.

Plate-, tunnel, and fluidized bed freezers

Plate freezers normally operate around -40°C and air blast freezers (ABF) in the range of -35 to -45°C. Subsequently, the product is commonly kept in the frozen state, typically around -30°C. In tunnel freezers, the freezing rate increases with increasing air circulation velocity (cold air from evaporator and fan) up to around 5 m/s. Fluid nitrogen gas (-196°C), or to some extent carbon dioxide gas (-78°C), may also be used in tunnel freezers as freezing medium. The gas is normally distributed countercurrent to the products to be frozen at the conveyor belt.

Several freezing methods are based on the use of cold air (gas):

- Cold storage – refrigeration by natural convection
- Tunnel freezers – air circulation by large fans either in an isolated room as batch or mechanized freezers, or by using belt freezers where the products are refrigerated continuously on conveyor belts
- Fluidized bed freezers – cold air is circulated from below which make the product spin and 'float' (e.g. IQF). Due to the large contact area, the heat transfer is efficient
- Impingement jet freezers – the products pass strong air jets created by nozzles. Liquid nitrogen can be used for this purpose. When the air jets hit the surface of the product, the stagnant boundary surface is destroyed whereby heat transfer is improved.

Various operational aspects concerning these freezing methods are discussed by Dempsey & Basal (2012). One of their conclusions is that there is a great potential to reduce the required energy consumption for freezing since up to 44 % of the total energy consumption is actually related to the removal of heat generated by the fans themselves in the freezing tunnels.

In case of plate freezers, the contact area (air pockets should be avoided) and block density are important variables. For example, the freezing time for fish blocks with density 650-800 kg/m³ and contact area 20-50 % will be about 3-4 h.

Lean fish contains more water than fatty fish. Water, and especially ice, has higher heat conductivity than fat. The freezing times of lean and fatty fish will depend on the Biot number (Bi). Biot's number is dimensionless quantity which describes the ratio of the heat transfer resistances *inside of* and *at the surface of* a body. This ratio determines whether or not the temperatures inside a body will vary significantly in space, while the body heats or cools over time, from a thermal gradient applied to its surface. Low Biot numbers ($Bi < 0.1$) imply that the heat conduction inside the body is much faster than the heat convection away from its surface, and temperature gradients are negligible inside of it. In this case, the freezing times decrease with increasing fat contents. Conversely, at high Bi numbers, where the internal conditions are dominating, the freezing times increase with increasing fat contents (Hardarson, 1996).

The modelling of freezing times in fish is a complex task, in particular due to the complex geometry and inhomogeneous composition of fish. Table 1 lists some typical freezing times for various fish species (Nicholson, 1982). Note that it was not stated how 'freezing time' was defined in terms of ultimate core temperature.

Table 1: Some examples of typical freezing times for various fishes. The refrigeration methods were vertical (VPF) and horizontal (HPF) plate freezers, and tunnel freezers (ABF) (Nicholson, 1982)

Fish product	Thickness (cm)	Refrigeration method	Initial fish temperature (°C)	Freezing temperature (°C)	Freezing time (h)*
Whole cod block	10	VPF	5	-40	3.3
Whole, single fish (cod, salmon etc)	12.5	ABF (5 m/s)	5	-35	5
Whole herring block	10	VPF	5	-35	3.3
Whole herring on metal tray	10	ABF (4 m/s)	5	-35	1.7
Cod fillets in laminated block packed in waxed cardboard	5.7	HPF	6	-40	1.3
Haddock fillets on metal tray	5.0	ABF (4 m/s)	5	-35	2.1
Haddock fillets in laminated block packed in waxed cardboard	3.7	HPF	5	-40	1

* final core temperature not stated

With adequate processing of fish on board freezing trawlers, it is possible to produce high-quality fish products. In case of cod, an example of this would be as follows. Cod (weight 2 – 4 kg) were bled in seawater (4 °C) and gutted on board after a 4-h haul. Gutted fish without head were frozen in a horizontal plate freezer or as individual prerigor fillets (500-600 g) in a freezing tunnel (IQF). In the latter case, the freezing was terminated when the temperature in the fish reached -28 °C after 70 min. Some of the fish were glazed for 10 sec in fresh water at 1 °C, while other fish were frozen directly, without glazing. All fish were placed in cardboard boxes and stored at -30°C. Later on, after the catch was brought ashore, some of the catch were thawed and filleted before they were frozen once again. All groups of fish were evaluated in terms of quality after 13 and 46 weeks. The best quality was obtained for the glazed fish followed by the non-glazed fish. The quality of the double-frozen cod was clearly inferior to fish in the other two groups, frozen on board only (Bøknæs et al., 2001). However, it should be pointed out that it is a controversial issue whether double-freezing leads to a reduction in quality (see references in Bøknæs et al., 2001). For the best possible quality, Bøknæs et al. (2001) recommend quick processing on board and to make use of glazing and freezing tunnel on board.

Fikiin (1992) designed a continuous fluidized bed concept for the freezing of fish (capacity 650-1500 kg/h). The freezing rate was higher than in tunnel and plate freezers. Cold liquid was sprayed through nozzles located underneath the fish. The fish were 'floating' and the good convection created rapid heat transfer. By using a brine (NaCl) at -15°C , the freezing times, defined as time to reach a core temperature of -8°C , were in brisling (10-15 g), horse mackerel (15-30 g) and brook trout (180-200 g) about 4 min, 8-12 min and 18-23 min, respectively. In all cases, the initial fish temperature was 25°C .

Brine freezing

Sodium chloride (NaCl) is often used for this purpose. The eutectic point of the phase diagram NaCl-water is at 23.3 % NaCl which corresponds to -21°C . Under commercial conditions, a somewhat higher temperature should be used for practical reasons. Calcium chloride might be used alternatively but in this case direct contact with the product should be avoided. Ethylene- or propyleneglycol can also be used under certain premises (Kolbe & Kramer, 2007).

Brine freezing of mackerel and horse mackerel (230-270 g) was not recommended by Aubourg & Gallardo (2005) since uptake of NaCl in white muscle resulted in increased rancidity (lipid oxidation) as determined by a sensory panel as well as by PV and TBA values. In practice, this means lower shelf life. On the other hand, the salt uptake lead to firmer flesh texture and less hydrolysis of lipids. The freezing method was carried out as follows: Brine (21 % NaCl) and fish was stirred in a tank at -18°C for 3.5 h. Note that the fish were directly exposed to brine in this study. The fish were removed and packed in PE bags before they were stored at -18°C for up to 9 months before assessment of quality.

Commercial freezing concepts

Some commercial freezing concepts are marketed as being able to produce top quality fish. Some of them do not seem to be related to any particular type of equipment, it is more like selling a concept for rapid freezing of (prerigor) fish, keeping low storage temperature (-40°C) followed by optimal thawing procedures. Sometimes also the preparation of the fish to make a high-quality dish is included in the concept. Two examples of such concepts are 'ICEFRESH'/ISFERSK' (www.isfersk.no) and 'TRUFRESH[®]' (www.trufresh.com). In the latter case, "a specially formulated brine" makes it possible to freeze vacuum-packed fish at -40°C .

Conclusion

High-quality fish can be produced by using the traditional freezing methods (plate, tunnel and fluidized bed freezers as well as freezing in brines) presently used in the fishing industry. It should be emphasized that proper on board handling practices and rapid freezing (pre-rigor, if possible) are important factors in order to achieve a good result. High freezing rates do not seem to be critical unless they are very slow. However, there may be other reasons to prefer high freezing rates such as factors related to processing line speed and capacity. Existing freezing methods may be optimized by making use of basic concepts for heat transfer. High pressure freezing is often referred to as a relatively new and promising technique for freezing of various products. However, due to very low freezing capacities, high investment costs and a number of different practical limitations, this technique is considered of low relevance for the fish industry today. By using available technology for freezing of fish in weak magnetic fields, no improvements were observed as compared with fish frozen by using traditional freezers. Concerning future developments, it should be mentioned that in the book '*Emerging Freezing Technologies*', Bejarano Wallens & Venetucci (1995) conclude that some of the main challenges for the industry using freezing technologies are related to a more energy efficient operation and development of more effective and economical cooling agents.

5.4.2 LF NMR method and development of customized data processing

Low-field NMR (often also called time-domain NMR) is a fast and powerful method that can be used for non-invasive determination of water and fat content as well as to study water and fat mobility in e.g. muscle

foods. The application of low-field ^1H NMR to fish and fish products opens up a possibility to relate the state and dynamics of water to various technological parameters, such as raw material quality, storage and processing conditions. Furthermore, the structure of muscles can be studied indirectly using low-field ^1H NMR. Different tissue water populations can be studied because protons in different environments exhibit different T_2 relaxation properties. Different approaches exist to extract useful information from raw CPMG curves. In the following, an overview of the data analysis methods applied in this project is given.

In general a T_2 relaxation curve from an object containing N relaxation populations can be mathematically described by a sum of N discrete exponential functions given by;

$$S(t) = \sum_{i=1}^N A_i e^{-\frac{t}{T_{2i}}} \quad (\text{Eq 2})$$

where $S(t)$ is the recorded CPMG signal, A_{2i} is a partial amplitude of the i -th relaxation component present in the curve and T_{2i} is its corresponding relaxation time.

In fish tissue a limited number of components have been identified in fresh (Andersen and Rinnan; 2002; Jepsen et al.; 1999), frozen/thawed, chilled and processed (Lillford et al.; 1980; Steen and Lambelet, 1997; Løje et al., 2007; Jensen et al., 2002; Lambelet et al., 1995) tissue and mince. In order to extract information from the relaxation curves several methods are available, each with their own strengths and weaknesses. The methods may be classified into single sample algorithms and multivariate data analysis. In the work of this thesis four different methods were combined.

The classical way of extracting information from relaxation curves is by *exponential curve fitting*. This is a single sample algorithm based on a predefined assumption of the number of components in the data set. This simple and robust method has traditionally been used to interpret T_2 relaxation data. However, one should remember that this form of data processing forces the curve to be fitted by a chosen number of exponentials. Therefore, it is important to thoroughly investigate the residuals of the exponential fittings, to make sure that the right number of exponents is chosen. A general rule is to find a minimal number of exponentials satisfactorily describing the experimental curve, such that additional exponents would not substantially improve the fit. In fish, two (biexponential) or three (triexponential) exponents are usually chosen (Eq 3 and Eq 4, respectively). Denote the signal amplitude S_i , where i is the number of exponential terms. Then, the biexponential and triexponential functions describing signal strength may be written as:

$$S_2 = A_1 e^{-t/T_{21}} + A_2 e^{-t/T_{22}} \quad (\text{Eq 3})$$

$$S_3 = A_1 e^{-t/T_{21}} + A_2 e^{-t/T_{22}} + A_3 e^{-t/T_{23}} \quad (\text{Eq 4})$$

Figure 4 shows typical residuals for mono-, bi- and triexponential curve fittings of T_2 relaxation data obtained on raw post-rigor Atlantic salmon (*Salmo salar*). The residuals are normalized with respect to the number of echoes. Approximately the same residual values were obtained for two and three exponents. This indicates that the main information stored in the data set is described by two components, i.e. the larger part of the tissue water is described by two main populations.

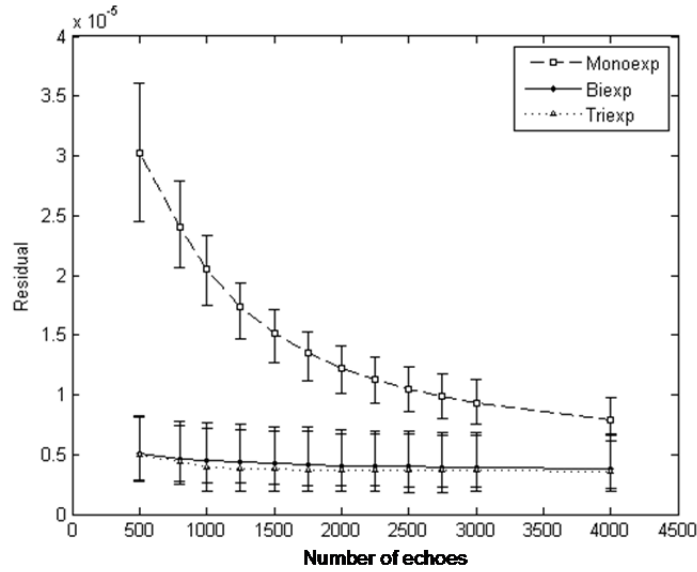

Figure 4: Normalized residuals of mono-, bi- and three exponential fitting to varying number of echoes (500 – 4000) of T_2 relaxation curves obtained on post-mortem Atlantic salmon muscle exposed to ante-mortem stress (n=6). Mean \pm max/min.

Another single sample algorithm to extract information from the T_2 data is *inverse Laplace transformation*. A commonly used implementation is the computer algorithm called CONTIN developed by Provencher (1982). This involves an iterative optimization-based search algorithm. Assume that the T_2 signal $S(t)$ is represented by Eq 2. Then, the Laplace transformation $F(s)$ may be written:

$$F(s) = \int_0^{\infty} S(t)e^{-st} dt \quad (\text{Eq 5})$$

The method gives an overview of the characteristics of the different water populations in the studied samples. The Inverse Laplace Transformation (ILT) is a highly ill-posed problem and is therefore intrinsically affected by numerical instability. The CONTIN algorithm searches for a $F(s)$ that fits the recorded $S(t)$. Data sets obtained from the experiments are affected by some noise, and this will have influence on the search algorithm. Numerical differentiation is involved in a regularization process during the search, and this is an operation very sensitive to noise. Thus, one should apply this algorithm with care. Its solution may not be unique, may not exist or may not depend continuously on the data. The output of the algorithm is only one of the possible solutions, and this limitation is unavoidable. Changing the parameters, the solution may change too. Despite these challenges, the use of ILT may be really successful if used together with other methods like for instance traditional exponential fitting. The latter results can be used to choose reasonable guess values for the inverse Laplace transformation calculations, and thereby give a more reliable convergence. Furthermore, noise may be reduced by low-pass filtering of the relaxation signal $S(t)$, providing a more robust input to the optimization search necessary for ILT estimates. Although such use of related methods will give dependency between results obtained by Inverse Laplace transformation and exponential curve fitting, the results are found to be important to support and elaborate the information found in the data set. In that way, more reliable results can be achieved.

Multivariate data analysis is another way of treating the relaxation data. By making use of the full data set from several samples at the same time, new possibilities arise. *Principal component analysis (PCA)* (Jolliffe, 1997; Martens and Martens, 2001) aims at reducing a large number of variables in the data matrix X , to a smaller number of uncorrelated “latent” variables or principal components (PCs). The PCs comprise linear combinations of the original variables. The first PC accounts for the main variation, while the second PC contains second most variation. That is, each new variable that follows, explains as much of the remaining variation as possible (Næs et al., 2002). The method is robust and rapid and can be performed directly on the

raw T_2 relaxation curves to investigate differences between sample groups etc. *Partial least square regression* (PLSR) is a multivariate statistical method that attempts to find the relationships between two matrices X and Y . The X matrix can i.e. consist of T_2 relaxation curves and the Y matrix of physico-chemical data. Like in PCA, the guiding principle for PLSR is a decomposition of the X matrix into scores and loadings. However, in PLSR the decomposition is governed by the variables of the Y matrix. In PLSR the response variables Y are expressed as a linear function of the variables;

$$Y = B_0 + XB + F \quad (\text{Eq 6})$$

where B_0 is the matrix of offsets with identical values in every column, B is the matrix of regression coefficients and F the matrix of residuals (Martens and Martens, 2001). The directions in this new co-ordinate space are given by the loading vectors and the new variables are ordered according to the magnitude of their co-variance to Y . The first PLS component contains the largest co-variance, the second PLS component has the second largest variation, and so forth (Næs et al., 2002). PLSR can be used for prediction of quality parameters, without having to pre process the raw relaxation curves to extract specific relaxation components explicitly. The technique has e.g. been applied in the determination of sensory attributes of potatoes (Thybo et al., 2000; Thygesen et al., 2001) The PCA and PLSR techniques are useful in the investigation of differences between groups, the location of potential outliers, or e.g. as a basis for calibration models in determination of quality parameters. However, these calculations cannot directly extract T_2 relaxation components. **Table 2** gives a summary of the T_2 relaxation data analysis methods used in the work in this project, their advantages and disadvantages.

Table 2: Low-field ^1H NMR T_2 relaxation data analysis methods, their advantages and disadvantages.

Data analysis method	Advantage	Disadvantage
<i>Single sample algorithms</i>		
Exponential fitting	T_2 relaxation times and populations can be calculated. Classical robust method. Easy to compare results with data in literature.	Risk of overfitting, close investigation of residual is essential.
Continuous distributed curve fitting / Inverse Laplace transformation	T_2 relaxation times and populations can be calculated. Results in a curve from which N is directly determined as the number of peaks. Dynamic changes in relaxation populations are easy to follow.	Highly affected by numerical instability.
<i>Multivariate data analysis</i>		
Principal Component Analysis (PCA)	Robust and rapid method. Good tool for building calibration models. Good performer when linear relationships are present. Most of the original variance is captured in a few principal components. Allows detection of underlying patterns and trends.	Sensitive to outliers in the data set. Can be hard to interpret the PCs. T_2 relaxation times and populations can not be directly calculated.
Partial Least Squares Regression (PLSR)	Good tool for building calibration models. Can be used for prediction of quality parameters. Calibrations are generally robust provided that calibration set accurately reflects range of variability expected in unknown samples.	Sensitive to outliers in the data set. Models are more abstract, thus more difficult to understand and interpret. Generally, a large number of samples are required for accurate calibration. T_2 relaxation times and populations can not be directly calculated.

The low field NMR method was used in this project to study chilled and frozen/thawed whitefish. The data processing was mainly based on exponential fitting: MatLab scripts have been developed for effective data processing.

5.4.3 Novel chilling and freezing technologies - effects on fish quality

Quality of Atlantic cod frozen pre rigor in Cell Alive System

A major part of the commercial catch of Atlantic cod (*Gadus morhua*) in Norway is frozen at sea after bleeding and gutting. Plate freezers are commonly used where the fish typically are frozen 1-3 h after the catch is taken on board. To obtain the best possible quality, cod fillets should be frozen in the prerigor state (MacCallum et al., 1968; Martinsdóttir and Magnússon, 2001). However, prerigor-frozen cod fillets can shrink rapidly during thawing (McDonald and Jones, 1976). Provided Atlantic cod are correctly frozen, stored and thawed, the market quality product can be good and of comparable quality as fresh fish (Vyncke, 1983).

Freezing of foods in magnetic fields has currently attracted much attention. However, scientific data to show the potential effectiveness of such freezers are scarce. Suzuki et al. (2009) carried out an experimental assessment of freezing of foods in a weak oscillating (50 Hz) magnetic field (0.5 mT). Among the products tested were bigeye tuna and yellowtail muscle samples (Ø 40 x 40 mm). No significant differences on freezing curves or product quality (drip amount, color, microstructure and sensory evaluation) were observed compared with control experiments. The Cell Alive System (CAS) freezing method represents commercially available freezers based on this technology. By using 60 Hz alternating magnetic fields of 0.1 mT with an induced electric field in a CAS freezer, inhibited ice crystal formation (Kaku et al., 2012) which was helpful for the survival of periodontal ligament cells after cryopreservation (Abedini et al., 2011). However, the claimed freezing mechanism and effectiveness of such freezers has been questioned (Wowk, 2012) and debated (Kobayashi and Kirschvink, 2014). In contrast to conventional freezing methods, where propagation of ice occurs from the outside towards the core of the product, it is claimed that the advantage of using CAS is that a considerable undercooling of the product takes place. Homogenous nucleation and instantaneous freezing will then occur throughout the product, preventing ice crystal formation due to the magnetic field vibration function prohibiting water molecules to make clusters during the freezing process (Takeda, 1991).

A related technology intended for chilled storage was evaluated by Hsieh et al. (2011) where fresh tilapia (*Oreochromis niloticus*) were stored at 4°C in a high-voltage electrostatic field (100 kV m⁻¹). Compared with traditional ice storage for up to a week, fish stored in the electrostatic field exhibited considerably fresher appearance and sensory characteristics, lower bacterial counts, lower K-values, and slower increase of volatile basic nitrogen.

Large supercooling can also be created by using pressure shift freezing where the chilled product is put under high pressure (for example 100 to 200 MPa). A rapid release of pressure produces supercooling causing quick and uniform nucleation in the product due to the shift in the freezing point to normal conditions. Higher pressure and lower temperature lead to more intensive nucleation and the formation of smaller ice crystals. It is well documented that under such conditions, the microstructure of for example Atlantic salmon (*Salmo salar*) (Alizadeh et al., 2007) and turbot (*Scophthalmus maximus*) (Chevalier et al., 2001) fillets have considerably less freezing damage and drip loss than fillets frozen by using air-blast or direct-contact freezers.

To our knowledge, no independent scientific evaluation of the CAS freezing technology for the preservation of fish is available. If successful, CAS freezing technology could constitute a potential method for the production of a high-quality niche product where the cod are frozen immediately after capture on board while the muscle cells are still alive. In the present research, our goal was to study the effects of freezing method on cod quality by comparing CAS freezing of unstressed Atlantic cod (with aerobic tissues) with traditional freezing of the same product in an air-blast freezer, or directly, in a cold storage room.

Publication I

Publication: Journal of Aquatic food product technology, accepted for publication.

Authors: Ulf Erikson, Elin Kjørsvik, Tora Bardal, Hanne Digre, Marte Schei, Tore S Søreide, Ida G Aursand

Title: Quality of Atlantic cod frozen pre rigor in Cell 1 Alive System, air-blast, and cold storage freezers

Abstract Gutted Atlantic cod, packed in cartons, were frozen immediately after killing in a magnetic field (Cell Alive System). The results were compared with traditional air-blast freezing, or by putting the cartons directly in a cold storage room (without forced convection of air). After frozen storage, external and fillet quality were compared. In spite of differences in freezing rates, only minor differences in cod quality were found among treatments. The mechanism for the freezing of fish in the magnetic field, under the current conditions, appeared to be similar to that of traditional freezing methods.

Cod and haddock stored in flake ice and slurry ice

A research cruise was conducted in 2010 on board the research vessel Jan Mayen. The fish was treated in two different ways after landing onboard, namely storage in seawater and storage in dry bins, thereafter the fish was stunned by electricity, gutted and cleaned. A reference group of fish bled, gutted and cleaned directly after landing on deck was also included in the experiment. Half of each fish group was stored in flake ice and the other half was stored in slurry ice. A flow sheet of the experiment is given in Figure 5. The results show that ice and slurry storage of cod (*Gadhus morhua*) and haddock (*Melanogrammus aeglefinus*) have an effect on microstructural changes, and that this differences can be detected by the rapid and non-invasive technique low field NMR. Furthermore differences in color and QIM-score were found for haddock stored under the two conditions. A more detailed description of the results will be given in the publication which will be submitted spring 2016.

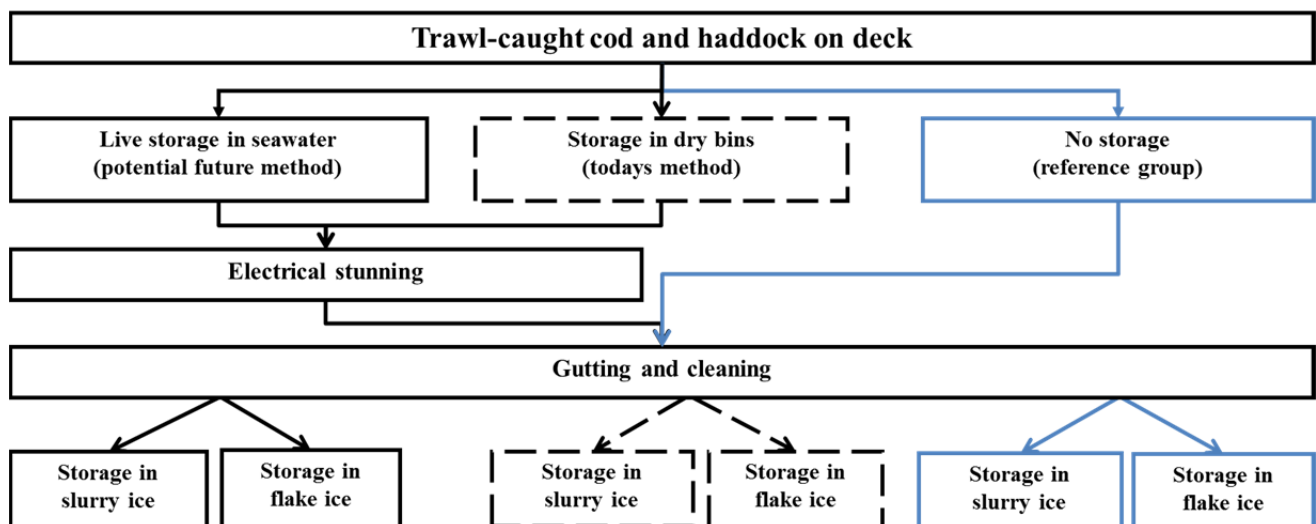

Figure 5: Flow sheet of experiment onboard Jan Mayen 2010.

Publication II

Publication: Manuscript under preparation will be submitted spring 2016.

Authors: Aursand, IG, Digre, H, Tveit, GM, Kjørsvik, E, Bardal, T, Lambooj, B, van de Vis, H, Grimsmo, L, Erikson, U

Title: Quality effects on wild cod (*Gadus morhua*) and haddock (*Melanogrammus aeglefinus*) chilled in slurry or flake ice

5.5 RA3: Energy systems

Background

New technologies have been introduced to decrease the fuel consumption of fishing vessels, increasing the complexity of the design choices. Such choices now include propulsion solution, such as hybrid, diesel electric and podded propulsion, the number and type of engines, the number and type of electric generators, and the kind of shaft generators (Wang, 2008). In addition, emission reducing technologies, such as catalysts, are available. These choices will to a great extent affect the vessel's fuel consumption and emission of NO_x (Stefanopoulou, 2009) and CO₂. Several studies show that there is a potential for reduction within the fisheries (Ellingsen, 2005), (Norwegian Pollution Authority, 2006).

A plethora of different brands and types of energy system components are currently available to the ship owners. These components will have different characteristics with respect to efficiency, heat transfer, costs, predicted maintenance and emissions. These characteristics are seldom available (Çelik et al., 2005) in the public domain, but some may be obtainable through requests. In other cases, these figures can only be estimated through knowledge about the physics of the component (Kesgin, 2003; 2004).

Initially, the activity within this research area was planned to focus identification of the most important energy system components and development of models. However, it was decided to focus on operational data acquisition through logging of variables such as energy consumption, instead of model development. Analyses of operational data will provide information about components of the energy system, the flow of energy and the catch handling in practical fisheries. Furthermore, the industry partners (fishing fleet) involved in the project are interested in this type of activity. The activity is called "low threshold logging", and will focus on logging of energy consumption without large changes or investment costs. The data can be used as a foundation for models of energy consumption on board and for a model of catch handling and quality.

Tasks

Research tasks

T3.1: Identify vessels for logging and design a logging system for each vessel.

T3.2: Acquire the necessary hardware for logging and develop the necessary software for the data acquisition.

T3.3: Install the logging system on the vessels.

T3.4: Develop and install the software for analysis of the vessels operation and consumption.

T3.5: Write peer-reviewed publication from the findings.

5.6 Results of RA3

5.6.1 Overview

Software for acquisition and storage of the operational data, as well as tools for analysing data, has been developed in cooperation between DANTEQ and the project *KMB IMPROVEDO*. The software development has also resulted in contributions to Unidata's (<http://www.unidata.ucar.edu/>) netCDF-4 C++ library (<https://github.com/Unidata/netcdf-cxx4>) and netCDF C library (<https://github.com/Unidata/netcdf-c>). The software developed here is being used and further developed in a number of other projects including: *Improvedo* (NRC #199570/O70), *PurSense* (NRC #226378), *ECO Shrimp* (NRC #235324/O30) and *eSushi* (NRC #245951/O70).

Operational data have been acquired on board the trawlers *Nordørn* and *Nordstar* since July 2012. Some analyses of these data will be presented below. Furthermore, these data are expected to be a valuable source for

further analyses. In particular, these data will be used together with a number of other data sources in the project *eSushi*.

5.6.2 Data acquisition and storage

The installed system for acquisition and storage of operational data on-board each vessel is comprised of a computer, a GSM modem, a motion reference unit, as well as several electric current sensors. In addition to acquiring information from sensors which are part of the installation, the system acquires several signals by interfacing existing on-board systems. The operational data are initially stored locally on-board. When the vessel is within range of the GSM network, the data are transferred from the on-board storage to a server on-shore. Lists of acquired signals for Nordørn and Nordstar are included in Table 3 and Table 4 respectively.

Several software components have been developed to handle the acquisition and storage of operational data, as well as a set of analysis tasks. Both DANTEQ and IMPROVEDO have contributed to this development. The SINTEF Fisheries and Aquaculture time series analysis framework (STIM) includes a software library and applications for handling storage and analysis of time series data. The binary netCDF (<http://www.unidata.ucar.edu/software/netcdf>) format is used to store the data. This data format provides platform independent files with compression and the opportunity to include metadata to describe the content of the files. Furthermore, several tools to access and manipulate netCDF files are available. A multithreaded software application for efficient processing of large amounts of time series data, STIM Analyzer, has also been developed. A number of modules or components which perform specific processing tasks have been developed. The different processing tasks and the flow of data between these tasks can be specified by the user in a configuration file. Processing tasks that can be performed by the implemented components include:

- Read from files
- Write to files
- Filter variables
- Run tests or arithmetic calculations on data values
- Categorization
- Finding distribution of categorized data
- Decimate
- Interpolate
- Calculate simple signal characteristics of time series
- Generate simple plots
- Generate histogram of signal value in bins according to categorization signals

5.6.3 Data integrity

During the project period the software has been continuously developed and updated on-board several times. There have also been issues with the hardware on-board. Equipment has been moved and Ethernet cables have suffered from broken leads, etc. An initial analysis of when the operational data have been acquired and stored correctly has therefore been conducted.

Methods

All files with operational data were first converted to the STIM netCDF format. Thereafter, custom Julia-scripts (<http://julia.org>) were used to reduce the data quantity. This was performed in two steps. In the first step each signal was assessed to determine if it was valid. A test criterion for a valid signal value was defined for each signal. It is not expected that the signal is necessarily invalid if this criterion is not fulfilled, but rather that for a valid signal the criterion will be fulfilled over time. For example, the test criterion for heading could be that the value is non zero and the absolute value less than 360 degrees. In that case, a heading of exactly zero would not fulfil the criterion, but if the signal is valid the heading is very unlikely to be exactly zero over any longer period of time. For each operational data file, containing an hour of operational data, the number of valid signal values for each signal was registered. The results were saved to a

single output file. In the second step the intention was to identify when no signals from a single source, such as signals obtained from a specific network connection, were valid. For each group of signals the maximal valid count of the signals in the group for each sample point in the output from the first step was registered. Finally, the results from the two analysis steps were inspected visually to determine periods where signals or signal groups were invalid.

Results

The operational data from Nordørn have long periods without valid acquisition of several signal groups, see Table 5. The factory data were only valid for a period of about nine months after the acquisition started. The two signal groups from the control room have also been invalid for long periods. There have been problems with the network connection between the SINTEF computer and the sensors in the control room. These problems include broken leads in the electrical wiring. In addition, the data acquisition system was not operational in two periods: 14 December 2012 – 28 December 2012 and 10 May 2013 – 30 August 2013.

Valid signals from the factory on-board Nordstar were recorded during the first 15 months, see Table 6. Within these months there was a three month period in which the accumulated weight and count signals probably were invalid. The remaining signal groups have valid signals for the entire acquisition period except for a period in which the data acquisition system was not operational: 31 December 2013 – 6 February 2014. However, a few errors on individual signals have been observed, see Table 7.

5.6.4 Operational profile

One of the use cases for operational data is to identify when the vessel is engaged in fisheries, steaming, at port et-cetera, in order to use this knowledge of operational patterns to improve future design and operations. This task is difficult to perform accurately, as there are no signals which directly indicate which operations the vessel is performing at any given time, e.g. when the vessel is towing the trawl. Such information must therefore be estimated based on combining information from several signals. Typical signals are the measured currents to the hydraulic winch pumps, vessel speed, trawl wire length and trawl winch speeds. The two latter signals are not available here, but measured current to the hydraulic winch pumps are a good indicator of the winch operations. When towing the trawl, the speed of the vessel would typically be in the range 3-5 knots, in addition to a high current to two of the hydraulic winch pumps. In the same manner, other combinations of several conditions will be typical of other operational phases.

Methods

Although a set of conditions is normally fulfilled when the vessel is performing a specific operation, there can be large variations in the measured signals. Consequently, it is difficult to achieve accurate identification of the operational phase based on hard thresholds for each condition. An alternative approach is to acknowledge that when the vessel is performing a certain operation, operational conditions such as vessel speed will vary within a range around a typical value. The best guess of the current operational phase based on the measured operational data would be the operational phase in which the measured combination of operational conditions has the highest probability of occurring. A simplified approach based on this idea has been used here. Rather than making a rigorous estimate for the probabilities of combinations of operational conditions in each phase, a simple *goodness of fit* parameter ranging from zero to one was calculated for each operational phase. A value of zero would indicate that the measured values did not match what would be expected in that operational phase, while a value of one would indicate that the measured values was in full agreement with the what would be expected in that operation phase. At each time point the operational phase of the vessel was assumed to be the operational phase with the highest goodness of fit. The goodness of fit for each operational phase was calculated from test on how well expected conditions were fulfilled. One such condition could be that the vessels speed is *high* with a test that would return a value of 1.0 if the speed is at least 10 knots, a value of 0.0 if the speed is less than 5 knots and a value that increases linearly between 5

knots and 10 knots. This method has the advantage that the correct operational phase can be identified even if some observed conditions does not match the typical values in the operational phase, as long as the correct operational phase has the highest goodness of fit, i.e. presumably is the operational phase that would most likely result in the observed operational data.

Using the method described above, the operations of Nordstar were categorized in six operational phases using operational data from 25 September 2012 to 7 March 2015. The operational phases were: *trawling*, *hoisting trawl*, *steaming – slow*, *steaming – fast*, *other* and *port*. A description of the conditions used to determine the goodness of fit for each operational phase is included in Table 8. The operational phase *other* is intended to include everything which cannot be categorized in any of the other operational phases with the available information. The STIM Analyzer software application was used to process the operational data and categorize the operational phases. Finally, an operational profile was generated by counting the number of sample points categorized in each operational phase.

Results

Visual inspection of the operational phase categorization indicates that the method performs well. Figure 6 shows the operational phase categorization and some relevant operational data for a 24 hr period. Figure 7 shows the first 5 hours in more detail. It should be noted that the operational phase *trawling* here only includes the period when the trawl is being towed. Shooting of the trawl is likely to be categorized in the *other* operational phase. Further, the operational phase *hoisting trawl* will probably only include the period when the trawl is hoisted from the bottom to the trawl doors reach the stern of the vessel.

The estimated operational profile for Nordstar in the period from 25 September 2012 to 7 March 2015 is included in Table 9.

Table 3 List of acquired signals on Nordørn.

Signal	Signal Group
Factory, Article Tank X, X=1,2,...,12	FactoryDataArticle
Factory, Accumulated Weight Tank X, X=1,2,...,12	FactoryDataAccWeight
Factory, Count Tank X, X=1,2,...,12	FactoryDataCount
Euler, x	MRU
Euler, y	MRU
Euler, z	MRU
Latitude	NMEA
Longitude	NMEA
GPS valid	NMEA
Speed over ground	NMEA
Course over ground	NMEA
Heading (Gyro)	NMEA
Rotation (Gyro)	NMEA
Longitudinal water speed	NMEA
Transversal water speed	NMEA
Water speed valid	NMEA
Longitudinal ground speed	NMEA
Transversal ground speed	NMEA
Ground speed valid	NMEA
Total distance	NMEA
Depth	NMEA
Main engine rpm	ControlRoomSensors1
Main engine load	ControlRoomSensors1
Pitch	ControlRoomSensors1
Rudder angle	ControlRoomSensors1
Shaft generator power	ControlRoomSensors2
Auxiliary generator 1, current	ControlRoomSensors2
Auxiliary generator 2, current	ControlRoomSensors2
Freezer current	ControlRoomSensors2
Winch pump 1, current	ControlRoomSensors2
Winch pump 2, current	ControlRoomSensors2
Winch pump 3, current	ControlRoomSensors2
Winch pump 4, current	ControlRoomSensors2
Delta velocity, x	MRU*
Delta velocity, y	MRU*
Delta velocity, z	MRU*
Rotation rate, x	MRU*
Rotation rate, y	MRU*
Rotation rate, z	MRU*

* MRU signals acquired at 100 hz and stored in separate file series

Table 4 List of acquired signals on Nordørn.

Signal	Signal Group
Factory, Article Tank X, X=1,2,...,18	FactoryDataArticle
Factory, Accumulated Weight Tank X, X=1,2,...,18	FactoryDataAccWeight
Factory, Count Tank X, X=1,2,...,18	FactoryDataCount
Euler, x	MRU
Euler, y	MRU
Euler, z	MRU
Latitude	NMEA
Longitude	NMEA
GPS valid	NMEA
Speed over ground	NMEA
Course over ground	NMEA
Heading (Gyro)	NMEA
Rotation (Gyro)	NMEA
Longitudinal water speed	NMEA
Transversal water speed	NMEA
Water speed valid	NMEA
Longitudinal ground speed	NMEA
Transversal ground speed	NMEA
Ground speed valid	NMEA
Total distance	NMEA
Depth	NMEA
Wind angle	NMEA
Wind reference	NMEA
Wind speed	NMEA
Wind speed unit	NMEA
Freezer new, current	ControlRoomSensors1
Freezer 1, current	ControlRoomSensors1
Freezer 2, current	ControlRoomSensors1
Rudder angle	ControlRoomSensors1
Pitch	ControlRoomSensors1
Main engine rpm	ControlRoomSensors1
Main engine load	ControlRoomSensors1
Main engine fuel	ControlRoomSensors1
Winch pump 1, current	ControlRoomSensors2
Winch pump 2, current	ControlRoomSensors2
Winch pump 3, current	ControlRoomSensors2
Winch pump 4, current	ControlRoomSensors2
Winch pump 5, current	ControlRoomSensors2
Winch pump 6, current	ControlRoomSensors2
Shaft generator power	ControlRoomSensors2
Auxiliary generator, current	ControlRoomSensors2
Delta velocity, x	MRU*
Delta velocity, y	MRU*
Delta velocity, z	MRU*
Rotation rate, x	MRU*
Rotation rate, y	MRU*
Rotation rate, z	MRU*

* MRU signals acquired at 100 hz and stored in separate file series

Table 5 Overview of which periods each signal group was found valid or invalid on Nordørn.

Signal group	Valid	Invalid
FactoryDataArticle	20120705T195937Z – 20130419T121944Z 20130618Y170806Z – 20131031T111814Z	20130419T124001Z – 20130510T150702Z 20131031T125848Z – 20150825T134742Z
FactoryDataAccWeight	20120705T195937Z – 20130418T212319Z (20131031T111814Z)	(20130419T124001Z) 20130418T222319Z – 20150825T134742Z
FactoryDataCount	20120705T195937Z – 20130418T212319Z (20131031T111814Z)	(20130419T124001Z) 20130418T222319Z – 20150825T134742Z
ControlRoomSensors1	20120705T195937Z – 20120918T115447Z 20120924T110553Z – 20130419T082319Z 20130619T170114Z – 20140101T222006Z	20120918T120001Z – 20120924T100553Z 20130419T230701Z – 20130619T162639Z 20140102T003259Z – 20150825T134742Z
ControlRoomSensors2	20120705T195937Z – 20120918T115447Z 20120924T110553Z – 20130419T082319Z 20130619T170114Z – 20140101T222006Z	20120918T120001Z – 20120924T100553Z 20130419T230701Z – 20130619T162639Z 20140102T003259Z – 20150825T134742Z
MRU	20120705T195937Z – 20150825T134742Z	
NMEA	20120705T195937Z – 20150825T134742Z	

Table 6 Overview of which periods each signal group was found valid or invalid on Nordstar

Signal group	Valid	Invalid
FactoryDataArticle	20120704T225712Z – 20131018T013752Z	20131018T022807Z – 20150307T035537Z
FactoryDataAccWeight	20120704T225712Z – 20130429T104432Z 20130731T172932Z – 20131002T173752Z	20130429T114432Z – 20130731T162932Z 20131002T183752Z – 20150307T035537Z
FactoryDataCount	20120704T225712Z – 20130429T104432Z 20130731T172932Z – 20131002T173752Z	20130429T114432Z – 20130731T162932Z 20131002T183752Z – 20150307T035537Z
ControlRoomSensors1	20120704T225712Z – 20150307T035537Z	
ControlRoomSensors2	20120704T225712Z – 20150307T035537Z	
MRU	20120704T225712Z – 20150307T035537Z	
NMEA	20120704T225712Z – 20150307T035537Z	

Table 7 Invalid signals in the operational data from Nordstar.

Signal	Period	Description
MainEngineFuel	Always	Value is zero (defective sensor?)
WaterSpeedValid / LongWaterSpeed / TransWaterSpeed	20140327T065945Z - 20140722T184418Z	WaterSpeedValid is set to true although LongWaterSpeed is fixed at a constant high value which is clearly invalid.
Euler_x/y/z / MRU	Multiple periods before 20131223T221538Z	Constant invalid values

Table 8 Conditions used for calculating the goodness of fit for each operational phase. Positive conditions increase the goodness of fit, while negative conditions decrease the goodness of fit.

Operational phase	Positive conditions	Negative conditions
Trawling	<ul style="list-style-type: none"> • High current to two winch pumps • Vessel moving at low speed 	<ul style="list-style-type: none"> • High current to four winch pumps • Vessel moving at high speed
Hoisting trawl	<ul style="list-style-type: none"> • High current to four winch pumps 	<ul style="list-style-type: none"> • Vessel moving at high speed
Steaming, fast	<ul style="list-style-type: none"> • Vessel speed at least 10 knots 	<ul style="list-style-type: none"> • Vessel speed at least 10 knots • High current to two winch pumps • High current to two winch pumps and less than four winch pumps on • High current to four winch pumps • Vessel moving at high speed • Speed over ground close to zero or invalid • Shallow depth • Low root-mean-square rotation rate
Steaming, slow	<ul style="list-style-type: none"> • Vessel moving at high speed 	
Other	Defaults to high	
Port	<ul style="list-style-type: none"> • Speed over ground close to zero or invalid • Shallow depth • Low root-mean-square rotation rate 	

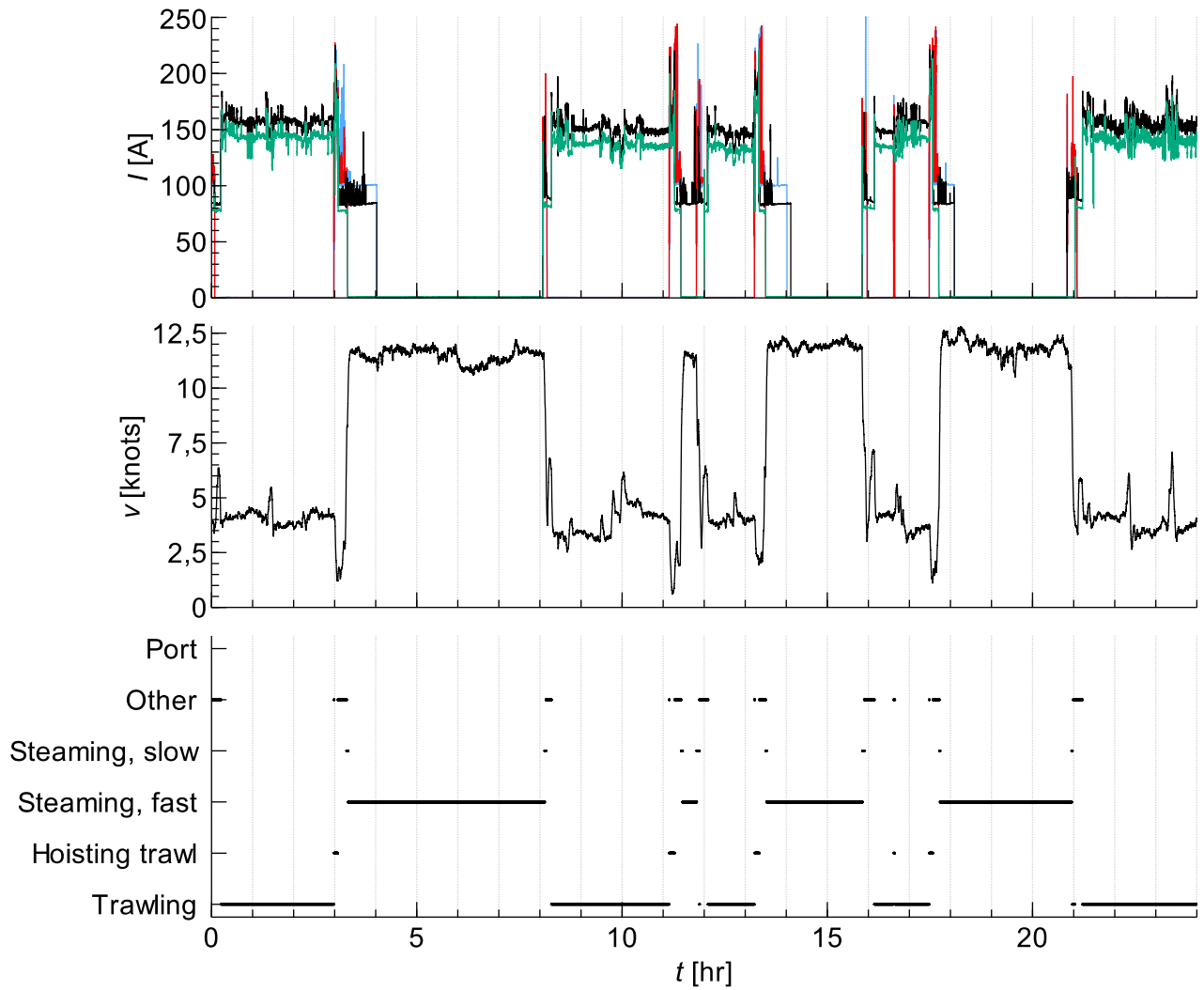

Figure 6 a) Current to winch pump1 (black), winch pump 3 (blue), winch pump 4 (red) and winch pump 6 (green), b) longitudinal water speed, c) operational phase.

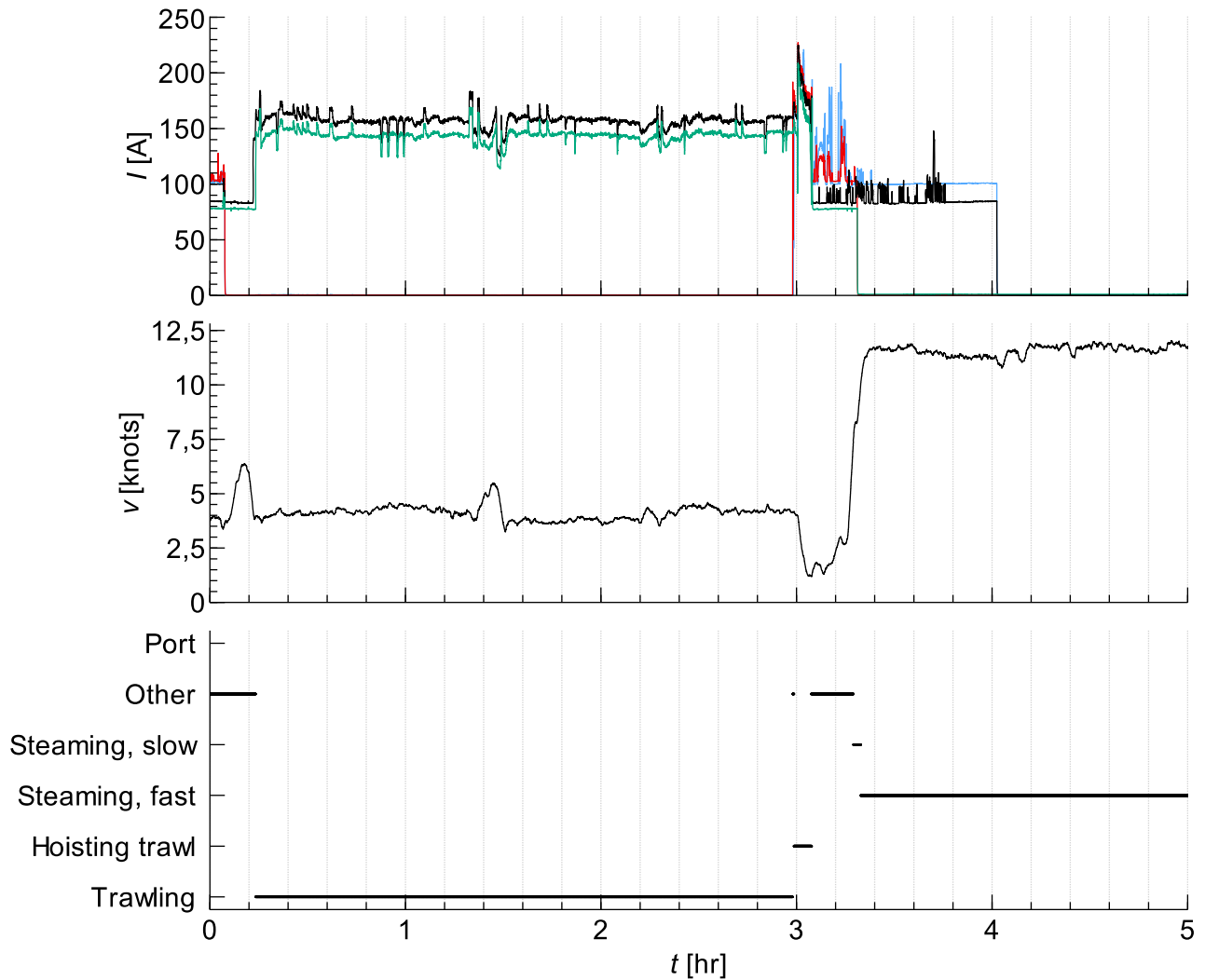

Figure 7 a) Current to winch pump 1 (black), winch pump 3 (blue), winch pump 4 (red) and winch pump 6 (green), b) longitudinal water speed, c) operational phase.

Table 9 Operational profile for Nordstar in the period from 25 September 2012 to 7 March 2015.

Operational phase	Time spent in operational phase	
	%	
Trawling	38.7	
Hoisting trawl	2.0	
Steaming	21.2	
Steaming, low speed	4.1	
Other	15.0	
Port	19.1	

5.7 RA4: Model synthesis – fish quality and environmental impact

Background

Fuel oil accounts for the primary expenses associated with operation of a fishing vessel and the NO_x and CO₂ emissions from the vessel are directly related to its fuel consumption. Even moderate improvements in the energy efficiency of fishing vessels have the potential to improve profit margins drastically as well as diminish the industry's environmental footprint, and there is great interest among shipowners and -builders in finding ways to achieve this. At the same time, fishermen also want to deliver high-quality product to their consumers, as this will often drive the price up. The question is whether the two goals of lowering energy usage and improving quality are somehow at odds with each other. For example, the refrigeration system is one of the major power consumers, both in terms of average consumption and peak loads, and it is known that freezing methods directly impact product quality.

A modern fishing vessel is a large and complex system, and the effects of various design choices and operational choices are seldom obvious. It seems likely that the on-board fish handling machinery, refrigeration systems, propulsion machinery and deck equipment are strongly interconnected, mainly because they compete for the same limited space and energy. Despite this, different subsystems and different aspects of the fishing operations are often considered separately and optimised independently, and improvements in one area could easily cause setbacks in others. Therefore, there is a great need for new and improved methods and tools for use in design processes and during operation, to help answer these questions.

In the early stages of the project, the idea for RA4 was to develop a simulation framework in which the most important subsystems that comprise an entire fishing vessel could all be simulated together. The goal was to enable analyses of the effects different subsystems have on each other and on the performance of the vessel as a whole. Examples of such subsystems include, but are not limited to,

- power generation (engines, generators, drives, etc.)
- hydrodynamics (propulsion, hull-water-interactions, etc.)
- deck machinery (winches, cranes)
- catch handling and processing (refrigeration, factory machinery, etc.)

This is a complex task involving several scientific disciplines, and early analyses and discussions quickly revealed that it would be impossible to achieve all this within the scope of one research project. This is both due to the amount of work needed to develop simulation models and software for just *one* of these domains, as well as the fact that different simulation methods are suitable for different domains, and combining and interconnecting different simulation methods is in itself a highly nontrivial task.

For these reasons, it was therefore decided early on that the project's ambitions needed some adjustment, and that DANTEQ would focus on simulating the catch handling processes on whitefish freezer trawlers—that is, what happens to the fish from the moment it enters the vessel up to the point when the complete product is put in cold storage. A literature search has revealed that very little work has been done in this area previously. Worth mentioning are the papers by Jonatansson & Randhawa (1986), in which the authors discuss simulations of land-based fish processing plants, as well as Randhawa (1994) and Randhawa & Bjarnason (1995) which focus on simulating the interplay between trawler operation and land-based processing plants.

It is worth mentioning that the other aspects of the original goal are being actively worked on in other research projects. Methods, models and software for simulation and optimization of machinery systems, especially power systems, have been developed in KMB IMPROVEDO (NRC project no. 199570/O70). Software and strategies for connecting mathematical models and simulations from different engineering domains in order to perform total system simulations is the main focus of the ongoing ViProMa project (NRC project no. 225322/O70). And finally, three of the recently started Centres for Research-based

innovation—especially SFI Smart Maritime, but to a certain degree also SFI MOVE and SFI EXPOSED—have dedicated major resources to tackling these and related challenges.

DANTEQ deals with two principal axes of improvement: energy efficiency and product quality. The only parts of a fish processing line which consume any significant amount of energy are the freezers, the question of energy efficiency can mostly be isolated to this subprocess. The effect of on-board freezing methods on energy efficiency and product quality was the topic of Christoph Backi's PhD thesis, which is described in sections 5.9 and 5.10. The remainder of the present section and the next deals primarily with *quality*.

Fish product quality depends on, and is influenced by, a large number of factors and subprocesses throughout the entire catch handling process. These will not be discussed in detail here, as this is a topic in itself, except the two most important factors *time* and *temperature*. Fish should be bled (or headed directly) while it is still alive or no more than 30 minutes after death, to ensure proper bleeding. This means that it should spend as little time as possible in dry storage after being brought aboard. After it has been bled, it should be processed and frozen as quickly as possible, as it is beneficial to the product quality.

To achieve this, an on-board factory must be designed and dimensioned according to the vessel's catch rates and patterns. Today, most factories on board trawlers are unable to process fish fast enough at peak loads. This, again, means that ship owners often have to redesign and refit their vessels' factories, which is both expensive and time consuming.

A simulation-based software tool could aid fish factory designers and owners in several ways:

- Process flow analysis (e.g. identification of bottlenecks, stress testing, capacity analysis).
- Understanding which subprocesses have the biggest influence on quality, and how.
- Improving routines during fishing and catch handling.
- Factory optimisation.

Examples of questions that could possibly be answered by such a software tool:

- Can a proposed factory design handle the vessel's expected catch rates, even at peak loads?
- What are the biggest bottlenecks in a factory?
- How does the inclusion or exclusion of one or more components (e.g. an additional heading/gutting machine, an electrical stunner, more buffer tanks, etc.) affect throughput and product quality?

The DANTEQ project has laid the foundation for such a software tool by developing methods, models and proof-of-concept software for simulating fish processing lines. The results are described in section 5.8.

Tasks

T4.1: System architecture

This task will specify the system architecture. This means how the different components will be modelled, how they are to interact, and what objective values they should calculate.

Method: This task must choose between two possible strategies to model the system at hand:

1. The quasi-static approach. In this case the operational profile will be a table of operational phases and the consumption of various components within these. It is here assumed that the consumption of individual consumers is constant (or has a statistical distribution). This may make it difficult to model for example fish quality to the necessary degree of accuracy, but it makes use of the model in optimization algorithms more feasible.
2. Dynamic modelling. The system is modelled as a series of interconnected differential equations. In this case the operational profile will consist of time-series of expected consumption of the consumers, covering typical use of the vessel. This would require more detailed models, and simulation would be more time consuming, but the results would probably be more accurate.

For each type of component, it must be decided how to model (inter- or extrapolation from a table of values or parameterized functions) and what to output and what to take as its input. These choices must be made based on what is available of data for the individual component, as well as a compromise between accuracy, simplicity and computational efficiency.

Delivery: An overview of the proposed system architecture.

T4.2: *Implement a common simulation framework*

The main objective of this task is to implement a common simulation framework according to the system architecture described in Task 4.1. This task will also be responsible for proposing objectives and weights and implement these in an objective function.

Method: It will be central to guide the Activities 1, 2 and 3 in model formulation and implementation. This will be done through exchange of personnel between the activities, as well as frequent meetings.

The major subtask in this Task will be to implement the common simulation framework for the models to be used. This framework should be fast enough to be possible to use in a optimization process, yet flexible enough to model various kinds of vessels and equipment. It will be implemented in C++, and the project will focus on flexibility and functionality over user friendliness. If it is chosen to base the framework on time-domain simulations, the software package FhSim will be used. FhSim is an API for solving ordinary differential equations developed by SINTEF Fisheries and Aquaculture.

The objectives and weights will be proposed based on the estimated value these will have for either the ship-owner or the society. Typical objectives will be emissions, fuel consumption, maintenance and initial cost.

Delivery: A description of the simulation framework and its implementation.

T4.3: *Implement a complete system model*

This task will aim at implementing running model of the complete vessel. The objective of this is to demonstrate the feasibility of the chosen methods, as well as to detect flaws in the design of the simulation framework or individual models at a relatively early point in time. It will also be a building block for future optimization routines to use.

Method: Using the simulation framework from the previous tasks, a complete system model will be built from the models created in the Activities 1, 2 and 3. Activity 1 will provide models of how choices made with respect to the fish handling affects e.g. the energy system and the quality of the fish. Activity 2 will provide models of the effect of various refrigeration technologies. Activity 3 will provide models of how various components of the energy system interacts and affects the design objectives.

Delivery: A running model of the complete system

T4.4: *Analyze system performance based on technology choices*

This task will run analysis of the complete system for various configurations with respect to chosen technologies, equipment and operational choices.

Method: Several possible combinations of machinery, cooling machinery, onboard handling equipment and operational choices will be identified. These combinations will be implemented in the software and evaluated with respect to the chosen objectives. The objective weights will also be varied, so that their influence on design and operational decisions can be analyzed.

Delivery: A report specifying the chosen systems and how they are evaluated against the various combinations of objective weights.

5.8 Results of RA4

5.8.1 Modelling and simulation methods

The method chosen in DANTEQ for simulating fish processing lines is called *discrete event simulation*. This is a method in which the passage of time is modeled as a series of discrete events, between which it is assumed that nothing of importance happens. For example, the case of a fish being transported on a conveyor belt could be modelled as two events, one when the fish enters the belt, and one when it reaches the end. The time between these two events is simply the length of the belt divided by its speed.

This can be contrasted with *continuous-time simulation*, which also models the passage of time as a series of discrete instants, but these are typically much more closely and regularly spaced so as to approximate continuous time. The evolution of the system between time points is usually described by differential equations. A prototypical example is that of a point mass connected to a linear spring, which is governed by the second-order differential equation $m\ddot{x} = -kx$, where m is the mass, k is the spring stiffness and x is the displacement from the neutral position. The length of the time steps in this case must be significantly shorter than the system's oscillation period in order to capture the dynamics in a realistic manner and maintain a stable simulation.

Discrete event simulation was chosen because it is able to represent the features of interest in the modelled system, especially the time spent by each fish in each process, in a very efficient manner. Process analysis and optimisation are common use cases for this simulation method. Continuous phenomena that occur between events, such as temperature changes, mechanical interactions, and so on, were typically approximated based on experimental data or simple assumptions. Continuous-time simulation could in theory be used to represent the system in much greater detail, but at the cost of increased computation time. It is worth mentioning, however, that even if the passage of time in the simulation as a whole is event based, there is in principle nothing that prevents subprocess models from performing their own, isolated continuous time evolution between events, though this will slow down the simulation.

Simulator architecture

We will now describe how discrete event simulation is used to simulate fish processing lines. The discussion will be kept at a general level, describing the structure of the modelled system and the event-based timeline. The proof-of-concept software which has been developed during the project, and which implements this structure, is only described superficially; few technical details are given.

There are four important concepts that together comprise the simulation structure: *process*, *item*, *port* and *event*. We will describe each of these in turn, and then illustrate them in terms of a simple fish processing line.

A *process* may be described as "something that happens over time". The system to be simulated is divided into several processes which are connected together. The granularity of this division (how many subprocesses there are, or, put differently, how much happens in each process), is a matter of choice, and depends very much on the processes in question and what one wants to achieve with the simulation. An example of a process is "fish is transported on a conveyor belt"; another is "fish are stored in a buffer tank".

An *item* is typically a "thing", i.e., some physical object which is part of the system being simulated. There may be any number of items, of several different types. Items may be moved from process to process, and each process may change them in some way. Processes may also create and destroy items. This means that processes may inject new items into the simulation and/or remove items from it. The simplest example of an item in this context is a fish. While a fish item is in a "conveyor belt" process, time passes and several properties of the fish—such as temperature, liveliness, etc.—may change. While it is in a "filleting" process, the "fish" item may be removed from the simulation and replaced by two "fillet" objects. More examples will be given later.

Items need not *necessarily* be physical objects, though; they could also be messages or control signals passing between processes. For example, an item could represent an electronic signal passing from the grader to the hatch on one of the buffer tanks, telling it to open or close to admit fish of the correct size and species for that tank.

Processes are connected by means of *input ports* and *output ports*. These are abstract model entities which represent the physical interfaces through which items enter and leave processes. As an example, a process which models a fish conveyor belt has at least one input port and one output port, where the former represents the beginning of the belt, where fish are loaded onto it, and the latter represents the end of the belt. If an output port is connected to an input port, items passing out through the output port will appear at the input port. This happens instantaneously; that is, no time passes in the simulation during such transfers.

Each output port *must* be connected to exactly one input port. If it were not connected, items passing through it would disappear, and if it were connected to multiple inputs, the simulator software cannot determine where to send each item. An input port, on the other hand, may be connected to any number of output ports, including zero.

It is important to note that, beyond the items going into or coming out of each process, the processes are completely isolated and know nothing about each other; nor does the simulation engine know what happens to items while they are inside processes. In principle, processes can be viewed as "black boxes" where the internal transition states are unknown until the output, or lack thereof, can be observed.

Finally, an *event* is a point in time at which the state of the system changes—that is, "something happens". These are defined by the processes themselves. Time progresses as a series of such events. A list of pending events is maintained by the simulation engine, which dispatches them to the appropriate processes in order of increasing time. In more colloquial terms, each process tells the simulation engine "at time T , something will happen here", and when all events prior to that time have been dispatched, the simulator engine tells the process, "the time is now T , so take action". Note that processes are *only* allowed to perform actions, including scheduling new events, at such event instances.

Example

To illustrate the concepts introduced in the previous section, we will use a simplified fish processing line consisting of four different process types:

1. *Receiving tank* (RT): In this process, fish simply lay and wait. The process has a single output port, through which fish are dispensed as fast as the connected process will take them.
2. *Conveyor belt* (CB): This process has one input port and one output port, representing the beginning and end of a moving conveyor belt. Its action is governed by three parameters: its length, L [m], its speed, v [m/s], and its capacity, c [items/m]. When an item enters its input port at time t , it schedules a new event for a later time, $t + \Delta t$, where $\Delta t = L/v$. When the simulator triggers this event, the process will send the same item out through its output port. If the density of items near the beginning of the belt exceeds c , it will close its input port for some time, until it is ready to receive more items. The reopening of the port must also be set up as an event.
3. *Heading/gutting* (HG): This process has one input port through which it receives round fish items, and one output port through which headed and gutted fish are sent. While in the process, fish items will have their liveliness status changed from "alive" to "dead".
4. *Buffer tank* (BT): This is similar but opposite to the receiving tank. It has one input port through which it receives incoming fish items at an unlimited rate. Once fish have entered the process, they simply lie in wait until the simulation is complete.

Using two instances of the "conveyor belt" process type to connect the other three, we then end up with the model shown in Figure 8.



Figure 8: Model describing a simplified fish processing line consisting of four different process types

Now, let's look at a possible event timeline for this process. For the sake of simplicity, we will assume a rather meager catch: only two fish items, f_1 and f_2 . Here's how this *could* play out:

t_0	RT sends f_1 through its output port. CB_1 receives f_1 , and schedules an event at a time point $\Delta t_{transport1}$ in the future for when f_1 reaches the end of the belt. Having no room for more items at the current time, CB_1 also closes its input port and schedules a reopening event at a time point $\Delta t_{reopen1}$ in the future.
$t_1 = t_0 + \Delta t_{reopen1}$	CB_1 reopens its input port. This causes f_2 to be sent from RT to CB_1 , and CB_1 again closes the port and schedules two new events: one for when f_2 reaches the end of the belt, and one for when the port should be reopened.
$t_2 = t_1 + \Delta t_{reopen1}$	CB_1 reopens its port, but there are no more fish items to be received from RT.
$t_3 = t_0 + \Delta t_{transport1}$	f_1 has reached the end of the belt and is sent to HG. HG can only take one item at a time, so it closes its port and schedules a time for when the heading/gutting process is complete, Δt_{HG} in the future.
$t_4 = t_3 + \Delta t_{HG}$	f_1 is now headed and gutted. HG sends it to its output port and reopens its input port. CB_2 receives it, closes its input and schedules two events like CB_1 did earlier.
$t_5 = t_4 + \Delta t_{reopen2}$	CB_2 reopens its input port.
$t_6 = t_1 + \Delta t_{transport1}$	f_2 arrives at HG. HG closes its input port and schedules an event for when f_2 has been processed.
$t_7 = t_6 + \Delta t_{HG}$	f_2 has now been headed and gutted, and is sent to CB_2 , which schedules two events as before.
$t_8 = t_7 + \Delta t_{reopen2}$	CB_2 reopens its input port.
$t_9 = t_4 + \Delta t_{transport2}$	f_1 arrives at BT.
$t_{10} = t_7 + \Delta t_{transport2}$	f_2 arrives at BT. The simulation is now complete.

A simple analysis of the above will tell us that it took time $(t_7 - t_0)$ before all fish were headed and gutted, and that it took time $(t_{10} - t_0)$ to process the entire "haul".

Stochastic modelling and emergent behaviour

The above example shows how the discrete event simulation works. As such, it was exceptionally simplistic, and not very interesting in terms of discovering new things about the process. We were able to describe the entire timeline in only 11 steps (and we could probably have predicted how long the process would take even without writing it down).

However, when the process line consists of many more subprocesses, with branches and even loops in their connections, and when it is simulated with several different hauls, where each haul consists of thousands of fish of different sizes and species, things become a lot more interesting and unpredictable. Even if the effect of each process on each item is defined by very simple rules, the interactions between multiple processes and multiple items may exhibit complex behaviour. This phenomenon is called *emergence*. Examples of emergent behaviour in this case could be unforeseen bottlenecks in the process, fish that spend an inordinate amount of time in one process.

The outcome of each simulation is made even more unpredictable by the fact that the processes are usually modelled in a stochastic manner based on real-world data. For example, let us consider a model of a manual heading/gutting process, i.e., a mathematical representation of a fisherman cleaning fish. We can determine experimentally that a fisherman uses, on average, T seconds to clean a fish, with a standard deviation of σ . Our process model, then, would, upon receiving a fish item at time t , schedule an event at some time $t + \Delta t$ for when the process is complete. The important thing is that Δt should be a *random*¹ number which is generated according to some statistical distribution, so that its expectation value is T and its standard deviation is σ .

This randomness allows the simulation to capture effects which would be difficult to introduce in a deterministic model, but which happen in the real world all the time. (For instance, the fisherman in the example above may step away from his post to talk to a colleague.) While it may seem artificial to introduce such "random occurrences" in a simulation of the processing of a single haul, the effects will even out when the simulation is run multiple times with multiple different input parameters. Even the hauls themselves, i.e., the initial collections of fish items, may be generated stochastically according to given size and species distributions.

5.8.2 Gathering background data: The 2012 research cruise

There is little experimental data available on the detailed effects of each individual catch handling subprocess on the quality of the fish being processed, especially with regards to how much time each fish spends in each process. This is needed in order to be able to build realistic simulation models. For the purpose of acquiring such information, project participants went on a research cruise with the freezer trawler *Arctic Swan* (IMO no. 9258739) in November 2012. Due to time and resource constraints, the data acquisition was limited to the two aspects which are considered most important to product quality: *time* and *temperature*. The experiments that were performed, together with measurement methods and selected results, are described in the following sections.

Since the purpose of the cruise was to gather data for mathematical models, the data have not been analysed or processed for any other purpose, and any results are presented in the form of examples of how mathematical models may be built based on the acquired information. However, the collected data is interesting in itself, and as soon as an opportunity presents itself, more work will be done to perform analyses on the relation between processing times and product quality,

Data was gathered in three different experiments—A, B and C—explained below, for 10 different hauls. All hauls were taken using a bottom trawl in a single-trawl configuration. Table 10 gives an overview of the hauls:

Table 10: Overview of hauls on the research cruise where data for a mathematical model was gathered.

Haul no.	Date/time of haul	Target species	Total catch weight [kg]	Experiment
4	2012-11-25 12:15	cod	28500	A
7	2012-11-26 07:10	cod	15600	B
8	2012-11-26 13:15	cod	12400	B
11	2012-11-27 06:20	cod	45000	B
12	2012-11-27 18:25	cod	12400	B
15	2012-11-28 08:30	cod	24000	C
16	2012-11-28 23:05	haddock	8500	B

¹ In practice, one typically uses a *pseudorandom* number generator.

19	2012-11-29 17:50	haddock	13600	C
22	2012-12-02 00:20	cod	6000	A
23	2012-12-02 02:15	cod	4400	A

Date/time of hauls is given as the time when the trawl was emptied into the receiving tanks.

Experiment A: Effects of keeping fish in the receiving tanks

Immediately after being brought aboard, the trawl is typically emptied into the *receiving tanks*, where the fish is kept in (dry) storage until it can be processed by the factory. The basic idea of "experiment A" was to measure the effect of this storage on the core temperature and liveliness of the fish.

Procedure

10 fish were randomly selected on the trawl deck, during emptying of the trawl. These were tagged with "sheep tags": coloured plastic tags featuring a three-digit number. The tags were attached to the fishes' gill covers using a sheep tag plier. The liveliness of the fish were assessed subjectively and graded on the following scale:

0	Dead
1	Motionless, but displays signs of life (vestibulo-ocular reflex, gill or fin movement)
2	Some wriggling
3	Vigorous movement

Their core temperature was measured internally with a probe, while the surface temperature was measured using an IR thermometer. The same fishes were then extracted right after they exited the receiving tank, at the beginning of the processing line, and the same measurements were performed again, together with a length measurement.

The experiment was performed for three hauls: 4, 22 and 23. Unfortunately, the first one was botched due to poor measurement methods. It took several attempts to settle on the best ways to acquire the temperatures. This resulted in great variations for the on-deck measurements in the first haul, which is certainly wrong considering that all the fish initially have more or less the same temperature—the seawater temperature. Though there may be small variations having to do with differences in the temperature near the sea floor and at surface level and the position of the fish in the trawl. The results from this haul were therefore discarded.

Example model

We now give an example of how the data collected in this experiment may be used to construct a linear regression model for the liveliness of the fish as a function of time spent in the receiving tank, focusing on haul 22. A linear model was chosen due to the very limited amount of data available (only 10 fish); we make as few and simple assumptions as possible. Although the liveliness was measured on a discrete scale (making it easier to perform consistent subjective assessments), the model will use a continuous scale.

As described previously, a process model receives items, makes changes to them, and passes them on to other processes at a later time. Assuming our model receives a fish with liveliness L_{in} at time t_{in} , and passes it on at time t_{out} , the model's job is to make an estimate of L_{out} . In a linear model, we then have

$$L_{out} = L_{in} + k(t_{out} - t_{in}) + \varepsilon,$$

with saturation at both ends of the interval $[0,3]$. Here, k is the regression coefficient, which for this haul was calculated (using the least squares method) to be $k = -0.0004$. ε is an artificial noise term which is randomly generated in such a way that the model exhibits similar variance to the measured data. Figure 9

shows the liveliness of the fish as measured in the factory (square markers) together with the linear fit (ignoring the noise term).

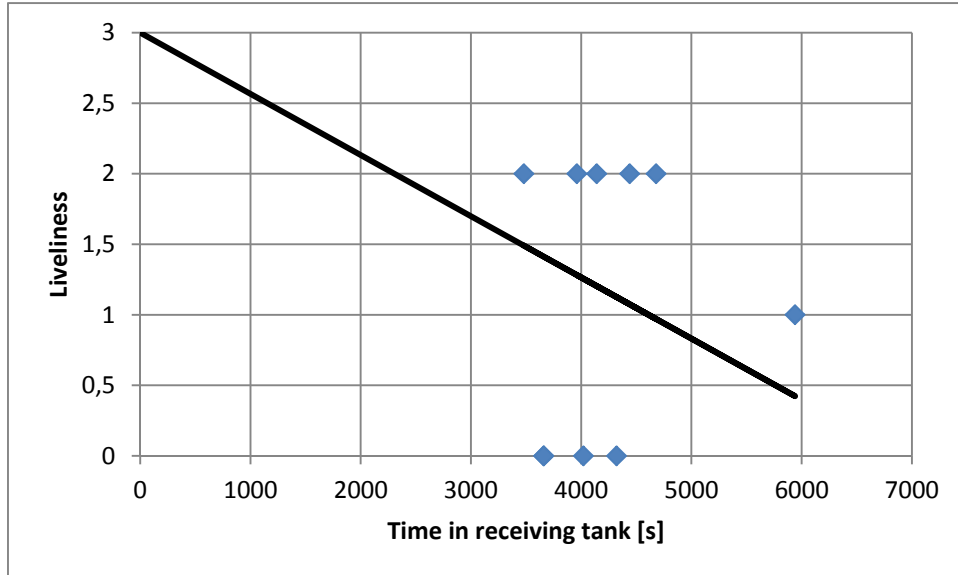

Figure 9: Liveliness of the fish as measured in the factory (square markers) together with the linear fit (ignoring the noise term).

Experiment B: Time usage and temperature changes throughout the processing line

The purpose of this experiment was to track individual fish through the processing line, from the moment they are headed/gutted to right before they are frozen, measuring how much time is spent in individual subprocesses, and how their core temperature changes as a result.

RFID-based measurements of processing time

The processing time for individual fish in the various subprocesses was measured by means of *radio-frequency identification* technology, or RFID for short. RFID antennas were mounted in strategic positions in the factory ceiling (see Figure 10), and randomly selected fish were tagged with RFID tags immediately after heading/gutting. Whenever a tag came in range of an antenna, the antenna number, the tag ID and the time was logged on a computer. When the tag left the antenna range, another log entry was made.



Figure 10: RFID antenna attached to factory ceiling, above conveyor belt to buffer tanks.

Attaching the tags to the fish in such a way that they were securely fastened and didn't fall off even in the event of rough handling, while at the same time positioning them so that they would be as visible to the antennas as possible, turned out to be a challenge. The antennas were unable to detect a tag if it was hidden underneath the body of the fish to which it was attached, or if it was underneath other fish. The tags themselves had to be robust and able to tolerate the rather harsh environment in a trawler factory, where they are exposed to physical shocks and stresses and at times submerged in seawater. Several different tag types and attachment methods were evaluated in the lab, prior to the cruise, before a satisfactory solution was found. Trondheim-based company HRAFN (from whom the RFID equipment was rented and tags were bought) were a great aid in selecting the best equipment for the job, as well as giving instructions for use.

The RFID tags that were used were of make and type *Omni-ID Max*: rectangular, flat, hard plastic tags with a screw hole in each end (see Figure 11). The tags were programmable, meaning that their ID number could be set manually using specialised hardware. Each tag was thus given a unique number which was both written on its casing in permanent marker as well as programmed into the least significant digits of its numeric ID.



Figure 11: RFID tags that were used were of make and type *Omni-ID Max*: rectangular, flat, hard plastic tags with a screw hole in each end.

The fish that were selected for RFID tagging were first tagged with sheep tags. In this case, the tags were attached to the fishes' tail (as opposed to the gill cover as in Exp. A), punched through the flesh and not the tail fin itself. Then the RFID tags were attached to the sheep tags using simple plastic zip ties threaded through one of the screw holes. Attaching them to the tail, which is the slimmest and thinnest part of the fish body, meant that they would be more easily observable to the antennas, whichever the orientation of the fish on the conveyor belt. Each sheep/RFID tag number pair was noted in the experiment journal for future correlation.

Figure 12 is a schematic F/T Arctic Swan's factory:

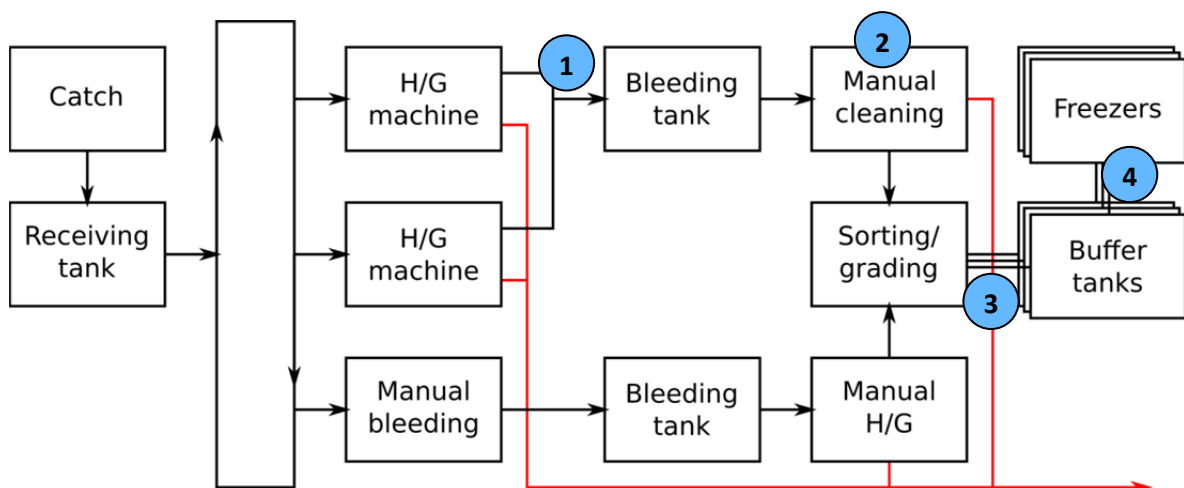

Figure 12: A schematic F/T Arctic Swan's factory.

The black arrows show the primary product flow (i.e., fish), whereas the red lines show the flow of offal (heads, guts, refuse, etc.). Most of the lines represent conveyor belts. The looping arrows on the left do in fact represent a conveyor belt loop: If the two H/G machines were unable to process fish fast enough, some fish would just continue past the machines to return to the same belt later. Fish that were too big for the machines, or which were of a species that the machines were not designed to handle, were bled manually and sent to a separate tank, from which they were later retrieved for manual heading/gutting.

The numbered circles indicate where the RFID antennas were placed:

1. Above the conveyor belt which transports fish into the bleeding tank, right before the tank. The tags were in the range of this antenna while the fish were on the belt, but not inside the tank.
2. Above the "cleaning table". Fish were lifted by a conveyor belt inside the bleeding tank onto a slide which led down to this table. Here, each fish would lie until a fisherman cleaned it (for remaining guts not removed by the machines) and placed it in the grader. The fish were in the range of the antenna while they were on the table and being handled by the fishermen, and went out of range when they were put in the grader.
3. Above the conveyor belt which leads from the grader to the buffer tanks. This is a fast-moving belt, so the tags were not in range for long, but this also means it is a pretty good point measurement of when the fish left the grader, as well as when they entered the buffer tanks.
4. Above the conveyor belt from the buffer tanks to the plate freezers.

Fish were tagged right before antenna 1, and the both the RFID and sheep tags were removed again right after they were registered at antenna 4. With this placement, it was possible to directly measure the following data for the tagged fish:

- Time spent in the bleeding tank, measured as the time from when the tag leaves the range of antenna 1 to the point where it comes into the range of antenna 2.
- Time spent on the cleaning table and during cleaning, measured as the time in which the tag is in range of antenna 2.
- Time spent in the grader, measured as the time after which the tag has left the range of antenna 2, up to the point when it is seen by antenna 3.
- Time spent in one of the buffer tanks, i.e. the time between antenna 3 and antenna 4.

Time data about other events, such as when the trawling started, when the catch was brought aboard, when the first fish entered the factory, etc. were logged manually, giving access to such information as how long the fish waited in the receiving tank, how long time it took from catch to freezer, etc.

Problems and limitations of the processing time measurements

While the RFID time measurements themselves went smoothly, controlling and/or monitoring the circumstances under which they were made proved difficult. The experiment was performed on a commercial trawler during normal operation, and the crew had to perform their tasks as efficiently as possible, in the same way that they usually work. This meant that:

- People moved between stations, making the throughput in each subprocess highly variable. For example, one of the persons manning the heading/gutting machines would perhaps leave that post and go to the cleaning table, to help deal with a congestion there. This would reduce the time spent by each fish in the cleaning process.
- There were times when all or parts of the factory were stopped altogether, due to coffee breaks, shift changes, heaving of the trawl, etc.

We had no way to keep track of these things, and they are expected to be a major source of error in the measurements. Other factors that likely had an influence on the measurements, and which we did not control or monitor were:

- Freezer throughput. A ship only has a limited number of plate freezers, and if they're all full, a lot of fish will be buffered in the buffer tanks waiting for them to be emptied.
- The fullness of the bleeding tank. This actually consisted of two separate tanks which could be filled and emptied separately, and we were not able to monitor which tank was in use at any given time.

Furthermore, the tank had a conveyor belt, which went all the way down to its bottom level, for transporting fish out of it. Whether this conveyor belt mainly transported fish from the bottom of the tank or the top of the tank most likely depended heavily on the amount of fish in the tank as well as the water level (which was controllable by the crew).

- "Special treatment" by the crew. While the fishermen were instructed to treat the tagged fish in exactly the same way as untagged fish, there is no way to be certain that this was in fact the case. It would be very human of them to be extra careful in an attempt to ensure that the tags did not fall off, and thus use more time on those particular fish in processes that involve humans.

Temperature measurements

The core temperature of individual fish was measured through parts of the processing line—the same parts for which the processing time was measured. Maxim iButton Thermochron temperature loggers were used for this purpose. These temperature loggers are small enough to be implanted in the fish, enabling them to sample and log the core temperature every 4 minutes throughout the process.

The Thermochrons were implanted right after the fish were headed/gutted, at the same time as the RFID tags were clipped on, right before antenna 1. The fish selected for temperature logging were a subset of the ones that were tagged. A small incision was made with a scalpel next to the dorsal fin and down to the backbone of the fish. Then the loggers were inserted into the incision, and pushed as close to the backbone as possible. Fish implanted with temperature loggers were removed at the end of the process, by antenna 4, and never went back into production.

The purpose of the measurements was to find how the core temperature of the fish varied during different processes. It was expected that this would be dependent on whether the fish were submerged in water, whether they were exposed to air, how long time they spent in each process, etc. Therefore, four additional pieces of data are needed, namely:

- The seawater temperature near the sea floor, as this is a good estimate of the core temperature of the fish when it is caught. Oceanographic simulations indicate that this was approximately 4 °C (unpublished data generated using the SINMOD model described in Slagstad & McClimans (2005)).
- The seawater temperature near the surface, as seawater is pumped into the factory and used in various processes (in particular the bleeding and buffer tanks). Oceanographic simulations indicate that this was approximately 5 °C (same model as above).
- The ambient temperature outside the vessel. This can be obtained from meteorological hindcasts, and for this cruise it was typically right below 0 °C (data obtained from *Yr.no*).
- The ambient temperature in the factory. This was measured throughout the cruise using one of the iButton loggers which was stable at 8.4±1.7 °C.

Problems with temperature measurements

Unfortunately, the temperature measurements turned out to be less useful than expected, at least for modelling purposes, because the core temperature of the fish didn't vary much throughout the processing line. The reason was that the ambient temperature in the factory was low enough that, given the rather short amount of time each fish spent exposed to air, this exposure did not cause a significant deviation from the initial core temperature. Any extended time spent by the fish in the factory was typically spent in the bleeding tanks or in the buffer tanks, where they were immersed in either seawater (pumped directly from the sea, and therefore having the same temperature) or other fish.

Another issue was that it took longer than expected for the temperature loggers to log a correct measurement after having been implanted in the fish. Depending on their starting temperature, the measurements did not stabilise at the appropriate core temperature until 10–15 minutes had passed after implantation, at which

point the fish had often passed *through* the bleeding tank and on to other processes. This is a significant source of error which makes the temperature measurements for that process unreliable.

One trend that could be observed, albeit a small one, was that the core temperature appeared to *drop* slightly between the time the fish were registered at the cleaning table (assuming that the measurement had stabilised) and the time the RFID tags and temperature loggers were removed at the end of the line. This could indicate that the temperature had risen somewhat from sea temperature while the fish were in dry storage in the receiving tank or in the bleeding tank, but due to the lack of measurements in the former and the measurement problems in the latter, it is hard to tell.

In conclusion, the temperature variations were too small and too uniform to be of much use in constructing statistics-based process models. Therefore, priority has been given in DANTEQ to processing and using the time measurements. However, it is hoped and expected that the data will be useful for other purposes, in other studies.

Example model

As an example, we will show how a simple stochastic model may be constructed for the "cleaning" process. We simplify by making the assumption that cleaning fish is a *Poisson process*: That is, that the average number of fish cleaned in a certain time interval is constant, and that the time taken to clean each fish is independent of the previous ones. Then, the time required to clean each fish follows an *exponential* distribution, whose probability density function is given by

$$p(\Delta t) = \lambda e^{-\lambda \Delta t}, \quad \Delta t \geq 0,$$

where Δt is the cleaning time per fish and the parameter λ is the inverse of the average cleaning time,

$$\lambda = \frac{1}{E[\Delta t]}.$$

Figure 13 shows the relevant data collected in all cod hauls on the *Arctic Swan*, that is, which proportion of fish spent a certain amount of time in range of antenna 2. Also included for comparison is the corresponding exponential distribution.

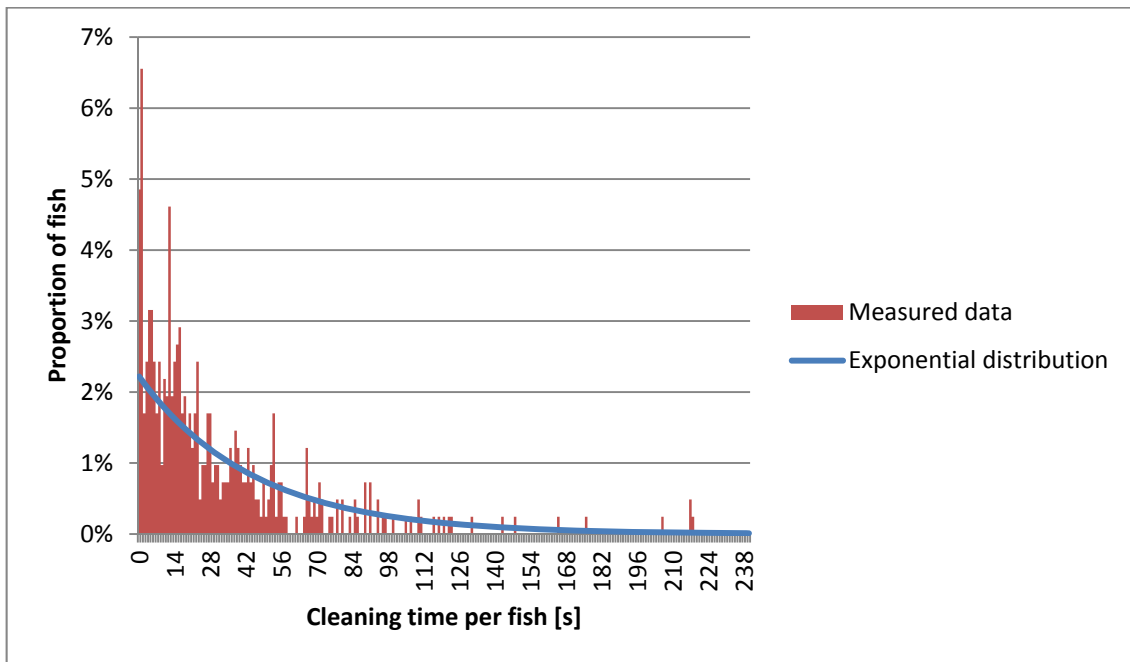

Figure 13: The relevant data collected in all cod hauls on the *Arctic Swan*, that is, which proportion of fish spent a certain amount of time in range of antenna 2.

It is seen from the figure that the exponential distribution provides a good fit to the measurements.

The discrete event model is then constructed as follows: For each incoming fish, generate a random number and schedule an event for that number of seconds later. The random numbers are generated in such a way that they follow an exponential distribution whose mean is given by the measured average cleaning time. (Note that this time, and thus the model, also includes the time each fish spends on the table before it is picked up and cleaned by one of the fishermen.)

Notes for future studies

As both the time and temperature measurements were fraught with errors of various kinds, the results from this cruise were not nearly as useful as it was hoped they would be. The following are a few recommendations that should be kept in mind if similar experiments are to be performed in the future:

- Instead of (or in addition to) tracking fish throughout the entire processing line, it would most likely be better to focus on individual processes at a time, and try to monitor and log more details of that process. For example, the time data for the "cleaning" process would be vastly more useful if one also knew how many fishermen were actively working at the table at any given time. For the "bleeding tank" process it would be very beneficial to know which tank was in use and how full it was (of fish and water).
- More care should be taken when performing the temperature measurements. If implanted temperature loggers are used, they should be given a "cool-down period" before the fish is reinserted into the process. However, if the previous suggestion is followed, it is probably just as well to measure the temperature manually for selected fish.

Note, however, that performing such detailed, manual, measurements will most likely require a lot more scientific manpower than was available for these experiments.

Experiment C: Factors that influence the degree of bleeding

The purpose of experiment C was to measure the effect of the following two factors on how well the fish was bled:

- The liveliness of the fish at the time it is slaughtered.
- Time spent in the bleeding tank after heading/gutting.

Procedure

Fish were selected at random before they were headed/gutted, and their liveliness was measured on the same scale as before. They were then tagged with RFID tags and reinserted into the processing line, where they were headed, gutted and transported into the bleeding tank. When the fish were transported out of the bleeding tank and onto the cleaning table they were removed from the process again, and the degree of bleeding was assessed subjectively using two measures: The colour of the flesh in the neck cut, which we will hereafter refer to as B_n , measured on the following scale:

$B_n = 0$	White flesh
$B_n = 1$	Pink flesh
$B_n = 2$	Red flesh

And the amount of blood in the abdominal veins, which we here call B_a , measured on the following scale:

$B_a = 1$	No blood in any of the veins
$B_a = 2$	Up to three blood-filled veins
$B_a = 3$	More than three blood-filled veins
$B_a = 4$	All veins contain blood

Using the same RFID setup as for experiment C, the time between antennas 1 and 2 was a good measure of how long the fish spent in the bleeding tank.

Unfortunately, in both hauls for which this experiment was performed (15 and 19), only a handful of fish were still alive at the time they were tagged. Therefore, there was insufficient data to make any kind of inference about the connection between liveliness and degree of bleeding. (To make matters worse, the fish species were different in the two hauls, so the amount of data *per species* is even less.)

Example model

We now show how a simple statistical model may be built based on the relationship between time spent in the bleeding tank and the degree of bleeding, using linear regression. First, we establish a single measure of the degree of bleeding, B , which we define as the sum of the two measures described in the previous section:

$$B = B_n + B_a$$

Using the method of least absolute deviations (LAD), we find the linear fit to the measured data from haul 15, where the blue dots are the measurements for individual cod, see Figure 14.

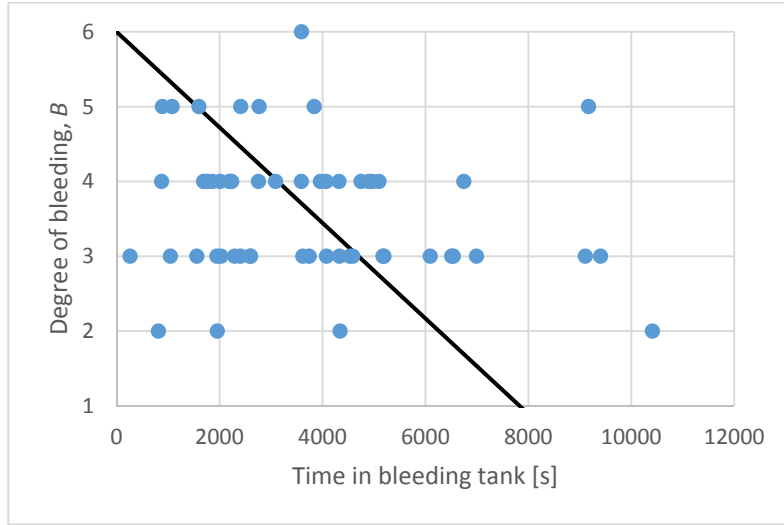

Figure 14: Linear fit between time spent in bleeding tank and degree of bleeding from haul 15, where the blue dots are the measurements for individual cod.

The line in this figure is given by the formula $B = 6 + kt$. The constant term is based on the quite reasonable assumption that, right after heading/gutting, B would have been assessed as 6 for every fish. The linear coefficient is $k = -6.38 \cdot 10^{-4}$.

Our process model is then constructed as follows: Each fish in the simulation has a *degree of bleeding* property, B , which is initially set to 6 for living fish. Let us say that the process receives an incoming fish at time t_{in} ; it then creates an event for a later time, t_{out} , when the fish leaves the process again. The degree of bleeding at exit is then calculated as

$$B_{out} = B_{in} + k(t_{out} - t_{in}) + \varepsilon$$

with saturation at both ends of the interval $[1,6]$. ε is a Gaussian noise term whose mean is zero (this was the reason we used the LAD method above) and whose variance is given by

$$\sigma = \frac{1}{N} \sum_N (B_{measured} - B_{linear})^2 \approx 2.5.$$

Here, N is the number of fish for which the bleeding was measured, i.e. the average of the squared differences between each measurement and the linear estimate of B for the same duration. Figure 15 shows the probability density of this distribution superimposed on a histogram of the deviations of measurements from the linear formula, indicating that the chosen method of noise generation is reasonable.

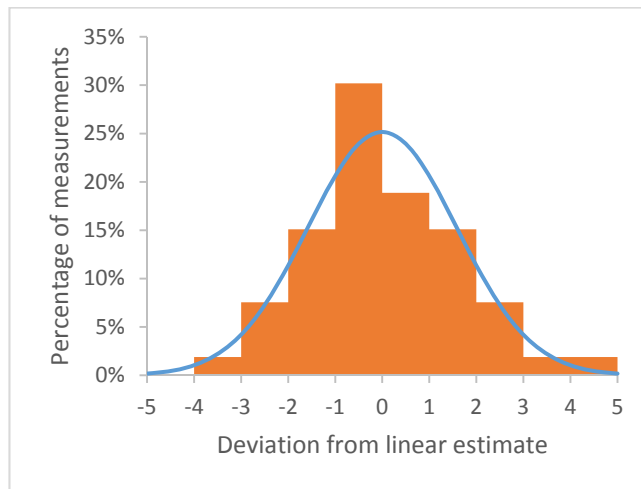

Figure 15: The probability density of the distribution superimposed on a histogram of the deviations of measurements from the linear formula, indicating that the chosen method of noise generation is reasonable.

5.8.3 Demonstration

We will now use the models described above, along with a few others not described here, to simulate a simplified whitefish processing line. The purpose is not to analyse a particular processing line, nor to give recommendations about how one should be designed, but rather to demonstrate how the simulator system can be used for such purposes in the future. It is important to note that, while the model is loosely based on the processing line on *Arctic Swan*, this is a constructed example specifically designed to demonstrate certain features.

Simulation setup

Figure 16 illustrates a possible "real-world" layout of the processing line we will simulate.

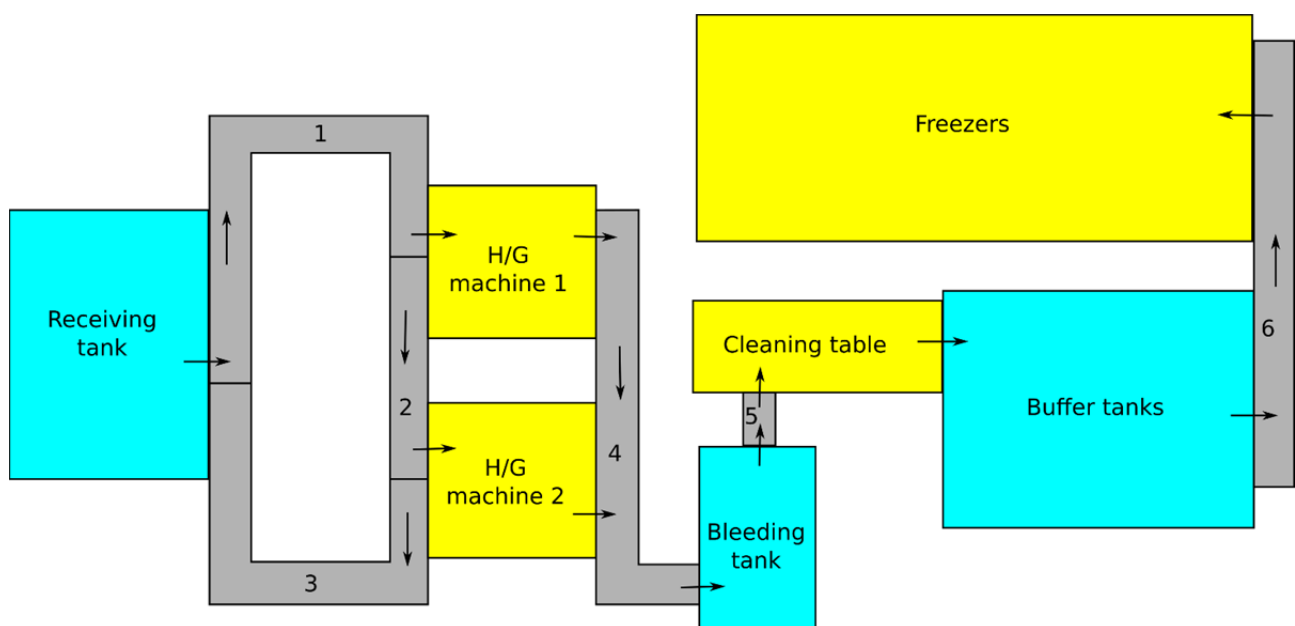

Figure 16: A possible "real-world" layout of the processing line we will simulate.

The grey areas represent conveyor belts. The arrows show the flow of the fish through the process, that is, both the direction of conveyor belt transport as well as movement of fish between processes. One of the simplifications made here is that the grader plus multiple buffer tanks have been merged into one "buffer tanks" area, and that multiple plate freezers have been merged into one "freezers" area. This is to reduce the complexity of the simulation model.

This translates into the model diagram shown in Figure 17, which shows the various subprocess models involved and how they are connected through input/output ports. (Some subprocesses of a more simulation-technical nature have been omitted for the sake of simplicity and clarity.)

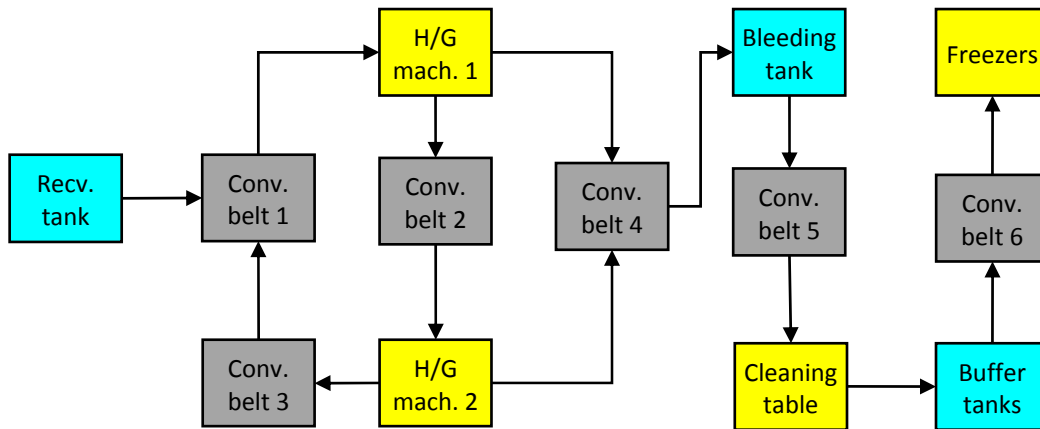

Figure 17: Model diagram showing the various subprocess models involved and how they are connected through input/output ports.

Here is a list of the various subprocess models, together with descriptions of their functions.

Receiving tank	Holds the fish at the start of the process, reducing liveliness over time (as described in section 0).
Conveyor belts	Holds fish for a certain time, which depends on the speed and length of the belt. The speed may be variable.
H/G machines	Kills fish (i.e., sets liveliness to zero) and heads and guts them. Throughput and number of fish inside the process at any one time is based on the specifications for the Baader 444 whitefish heading/gutting machine.
Bleeding tank	Holds the fish after heading/gutting, reduces degree of bleeding over time (as described in section 0).
Cleaning table	Holds the fish for a certain amount of time, as described in section 0.
Buffer tanks	A simple first-in-first-out buffering process; fish may be inserted at any rate, and are removed again as fast as conveyor belt 5 will take them (which is again limited by freezer capacity).
Freezers	Receives fish with a certain rate until freezers are full, then stops receiving fish until fish is frozen and the freezers have been emptied.

There are a large number of adjustable parameters in the model. Some were chosen based on measurements, and some are based on assumptions and "qualified guesses". The accuracy of these parameters is not important for demonstration purposes. Some central parameters are:

Conveyor belts	Speed of belt 1–4 is 0.05 m/s. Speeds of belt 5 and 6 are variable, depending on the ability of the next process to receive.
----------------	---

	Lengths: L1 = L3 = 8 m, L2 = 2 m, L4 = 7.5 m, L5 = 1.5 m, L6 = 12 m.
H/G machines	Throughput (per machine): 15 fish/min
Bleeding tank	Maximum capacity: 1000 kg
Cleaning table	As described in section 0, with the assumption that there were on average 3 persons at the table during those measurements and that throughput is proportional to the number of people manning the table.
Freezers	Two independent freezer banks, each containing four plate freezers with an individual capacity of 625 kg (25 blocks of 25 kg). Each freezer takes 7 mins. to fill up, and a bank takes 3 hours from the moment all freezers are full until they are done freezing and ready for the next load.

To mimic the actions and decisions of humans in the process, we furthermore introduce the following rules, or "script", for the simulation:

- Processing does not start immediately; the fish spend some time in the receiving tank before the other processes start.
- Initially, both H/G machines are manned, there are 2 persons by the cleaning table and none at the freezers.
- If the bleeding tank reaches its maximum capacity, the person manning H/G machine 1 moves to the cleaning table until the level has dropped to 1/3 again, at which point he returns to the H/G machine.
- An hour after the processing starts, one person moves from the cleaning table and starts filling the freezers. Once all freezers are full he moves back to the cleaning table, et cetera.

Regarding the first point: In the real world, the crew often have tasks they need to perform before they can start processing a haul; for example, the trawl needs to be cleaned, processing of the previous haul must be completed, the freezers have to be emptied, et cetera. The time spent by the fish in the receiving tank before processing was recorded for several hauls on the research cruise.

We will use information noted about one of the hauls aboard *Arctic Swan* (haul 12) to initialise the simulation:

Total catch weight	11941.6 kg
Time in recv. tank before processing starts.	20 min.
Fish species (primary)	Cod
Average fish length \pm standard deviation	65.5 \pm 8.6 cm
Average weight/length ³ ratio	12.5 kg/m ³

Some of the data in this table were obtained in the course of a different project participating on the same cruise; see Grimaldo et al. (2013).

Results

The best way to get an overview of the process flow is perhaps the graph in Figure 18, which shows the number of fish in certain processes at any given time.

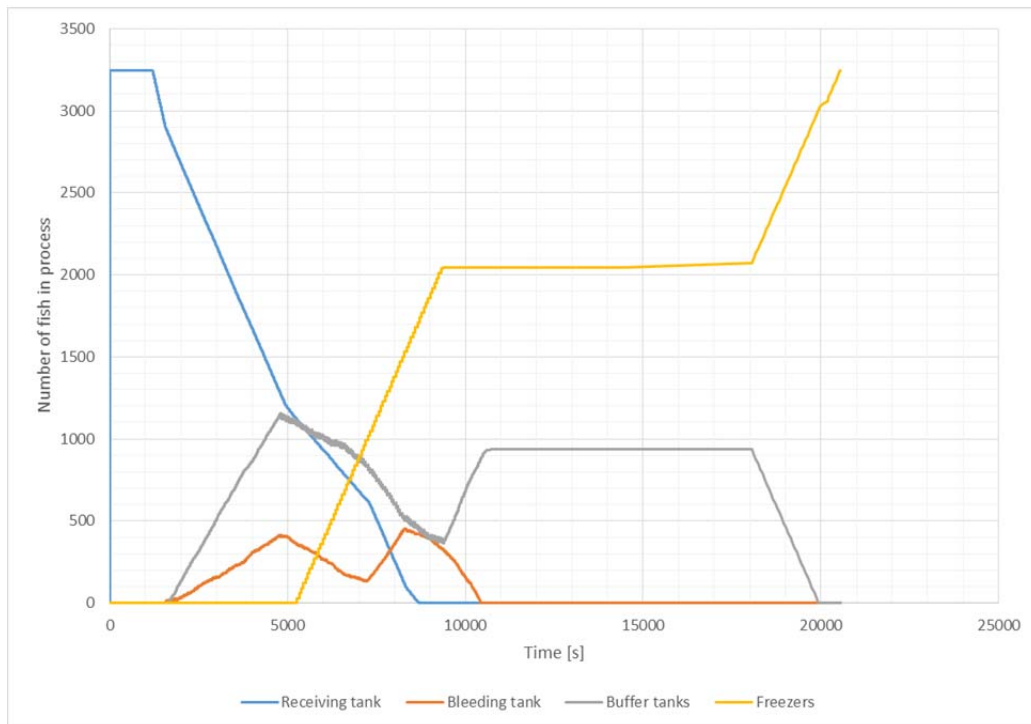

Figure 18: The number of fish in certain processes at any given time.

Note that the "freezers" graph show how many fish have entered the freezing proces *in total*, and does not drop to zero when the freezers are emptied. With that in mind, here is what we can read from this graph:

- At 1200 s, the processing begins and the number of fish in the receiving tank starts to decrease.
- At about 1500 s, the first headed/gutted fish reach the bleeding tank and it starts to fill up.
- Shortly thereafter, the first fish have also passed through cleaning and entered the buffer tanks, which also start to fill up.
- Somewhere around 4700 s, the bleeding tank has reached its maximum capacity. According to our predefined rules, one of the people manning the H/G machines moves to the cleaning table. From this point, the receiving tank is emptied at a slightly slower rate since only one machine is in operation, and the amount of fish in the bleeding tank starts to decrease.
- Almost at the same time, at 4800 s, one person moves from the cleaning table to the freezers and starts filling them. We see that the number of fish in the freezers increases steadily, while the number of fish in the buffer tanks decreases.
- At roughly 7400 s, the bleeding tank is only 1/3 full, and one person moves back to H/G machine 1. The emptying rate of the receiving tank picks up again as a result, as does the filling rate of the bleeding tank.
- At about 8700 s, the receiving tank is empty.
- At about 9400 s, the plate freezers are completely full. This is followed by a long period where no more fish enter the freezers, and where the buffer tank fills up.
- The buffer tanks quickly reach a maximum level and stay there until the freezers have been emptied and are ready to accept more fish, at about 18000 s.
- The last fish is put in the freezer after 20500 s—i.e., 5 hours and 41 minutes.

One can see that, initially, the cleaning table is a limiting factor in terms of process throughput. The H/G machines process fish faster, and the bleeding tank fills up quickly. Moving one crew member from one to the other makes the whole difference. Later, the freezers become the major bottleneck (which is often the case in real life).

The simulator is capable of generating many other statistics, being limited only by what the various subprocess models provide. Some examples for this simulation run include:

- *Liveliness at heading/gutting time*: Roughly 61% of the fish were still alive when they entered the H/G machines. Here, we have defined "alive" as having a liveliness greater than or equal to one, as calculated by the receiving tank process model. The average liveliness was 1.2 (on a scale from 0 to 3), indicating that, while alive, most of the fish were in a very poor shape.
- *Degree of bleeding*: Due to the lack of a "liveliness" component in the bleeding model (see section 0), this statistic is not very reliable, and we include it only as an example. The average degree of bleeding, on a scale from 1 to 6 where 1 is perfectly bled, was 4.8 with a standard deviation of 1.5, indicating rather poor bleeding.
- *Rigor mortis*: This has not been mentioned previously in this report, but the simulator also calculates *rigor status*, on a scale from 0 to 5, where 5 is full rigor. This model is based on the raw data collected for Erikson et al. (2009). For the present simulation run, the average rigor status of the fish was 0.37; rather low, as expected since the entire haul was processed in less than 6 hours.

While we will not go into further details here, it should be mentioned that for each of these statistics, as well as many others, it is possible to extract more detailed data from the simulator, even down to a per-fish level.

5.8.4 Outlook

The work performed in RA4 has resulted in a proof-of-concept technology that can potentially be useful for a number of purposes:

- Evaluating different choices during the design of a processing line. (The various alternatives can be represented as simulation models and run against multiple simulated hauls that represent the vessel's catch patterns.)
- Process optimisation and bottleneck elimination.
- For redesigns/rebuilds of existing factories, determining which changes will have the most impact to achieve the desired efficiency, so it can be done as cheaply as possible.
- Predicting the effect of changed fishing patterns (fish species, catch rate, haul size, etc.) on product quality.

Before this can be properly realised, however, some further work is needed:

- *New and improved mathematical/statistical models*: As has been described in previous chapters, obtaining good data on which to base the models proved very challenging. However, with the experience gained in this project, we believe it is possible to design improved experiments that will result in more reliable measurements, with less noise, which will hence lead to more accurate models.
- *Model validation*: Before the simulation results can be trusted to represent reality, they need to be validated against real-world measurements. The experiments performed in the November 2012 research cruise were not designed for this purpose, and furthermore, validating the models against the data used to derive them is not ideal. Instead, data should be collected over a long time, for many hauls and preferably with several different vessels, and compared against a large number of simulation runs. Note that for this purpose it is not necessary to perform detailed measurements on individual subprocesses; rather, one should gather overall haul data such as total processing time and final product quality.
- *Software improvements and streamlining*: As the software developed in this project was never intended to be an end-user tool, but only a proof of concept to be used for research purposes, no attempt has been made to keep it user friendly. Quite some work is required to set up a simulation,

and it requires programming skills to do so. More work is needed to turn this from a research tool into industry-ready software.

5.9 PhD thesis: Modeling, Estimation and Control of Freezing and Thawing Processes - Theory and Applications

The work of the PhD student Christoph Josef Backi resulted in a thesis titled “Modeling, Estimation and Control of Freezing and Thawing Processes – Theory and Applications”. Thereby the focus was on developing and improving existing models describing phase change phenomena during the freezing and thawing of foodstuff. The foodstuffs of main interest were thereby fish and fish-products. As the title of the thesis states contributions include the investigations of both theoretical and applied nature for freezing and thawing processes. Especially the temperature dynamics in plate freezers and contact thawing devices were of large interest.

The theoretical contributions include development of mathematical models in form of partial differential equations derived from the so-called diffusion equation. Investigation of this partial differential equation with respect to stability in a control engineering sense has been conducted. The novelty hereby is that the parameter functions of the model explicitly depend on the state variable (temperature) rendering the partial differential equation nonlinear. A *stability analysis* has not been carried out for this kind of system before. Furthermore, *relationships* between the mathematical model and related partial differential equations were highlighted. In particular the so-called Burgers’ equation and its potential form were highlighted as related equations to the (nonlinear) mathematical model.

Applications of the model in the context of freezing and thawing of foodstuff included the development of algorithms that enable the *estimation* and thus monitoring of the unmeasurable temperature field inside the inner spatial domain of the good to be frozen or thawed. Full knowledge of the temperature distribution inside the spatial domain is beneficial when aiming to control the processes of freezing and thawing in plate freezers and contact thawers, respectively. In these systems the only way of controlling is via the boundaries, meaning that temperatures at the respective boundaries have to be imposed. Additional contributions included the development of algorithms providing an *optimal boundary temperature* with respect to predefined constraints to the systems. The result of these algorithms was also beneficial to saving energy during the freezing and thawing operations, as too low and / or too high temperatures could be avoided.

5.10 Results of the PhD thesis

The work conducted during the PhD studies has resulted in 12 international publications. One of these publications is the PhD thesis. Two of these publications are to be submitted in the near future, one to a journal about food processing and the other one to a conference in control engineering. One publication is not yet published, but accepted for publication in a journal in the field of control engineering. Three publications were handed in as extended abstracts and presented in the form of posters at international workshops. Five publications were full peer-reviewed papers published in the proceedings of international conferences. In the sequel all publications are listed.

Thesis: PhD, NTNU, Department of Engineering Cybernetics, SINTEF Fisheries and Aquaculture
Authors: Christoph Josef Backi
Title: Modeling, Estimation and Control of Freezing and Thawing Processes - Theory and Applications

Summary: Fisheries and aquaculture are very important sectors in the Norwegian industry. Fish and its by-products are popular foodstuff as they are considered to be healthy, especially due to their nutritional value. Therefore, consumer safety is a very important topic and methods for prolonging shelf-life play an important role in the fishing and aquaculture industries. These methods are mostly based on cooling and freezing

techniques, as bacteriological and enzymatic activities are generally reduced at low temperatures. However, freezing and cooling are quite energy- and time-consuming. Freezers are often designed as batch-operations, especially on board fishing vessels, and thus act as bottlenecks in the production chain. Therefore, an optimal operation avoiding overfreezing has to be imposed, where the term overfreezing denotes the operation, when a good is in the freezer longer than necessary. Hence, the aim is to monitor and operate the freezing processes in an optimal way with respect to quality, but also with regards to energy use and environmental impact. This can be achieved by a better understanding of the factors that influence the quality of fish and seafood during freezing and thawing. Furthermore, comprehension of the actual processes that happen during phase change are of importance; this includes the derivation of mathematical models to describe the temperature evolution in the food. The thesis is structured into five parts, which are divided thematically: Introduction and preliminaries, mathematical modeling, applications, experiments as well as closing remarks. Part I gives an introduction to the context of this thesis. The importance of the fishing industry for the Norwegian economy is highlighted. Furthermore, preliminaries about topics related to freezing and thawing of foodstuff in general, and fish and fish products in particular, are presented. These preliminaries include methods of industrial applicable and more theoretical nature. Furthermore a Chapter is dedicated to the concise introduction to quality aspects of fish, in a general way, but also with respect to freezing and thawing applications and processes. In Part II, a mathematical model for freezing and thawing processes are derived from the diffusion equation, a partial differential equation (PDE). This model represents a form of a linear heat equation, which is extended by a nonlinear term. This nonlinear term enters the equation due to the fact that phase change occurs in both freezing and thawing, and therefore the parameters of the diffusion equation are modeled state- and thus temperature-dependent. Similarities between this model and other types of PDEs, in particular the Burgers' equation and its potential form, are investigated. However, due to the state-dependency of the coefficients, known transformations can not be applied in order to use already established stability results for this kind of heat equation. Therefore, the stability of the model is investigated. This is conducted in order to show that the model can be used for describing freezing and thawing applications, which are in fact known to be stable due to the laws of thermodynamics. Part III presents applications of the model derived in Part II for freezing and thawing processes, respectively. Firstly, an observer based on an Extended Kalman Filter (EKF) is developed for both, freezing in plate freezers and thawing in contact thawing processes. The aim is to estimate the temperatures in the inner domain of a block of foodstuff. Therefore some assumptions have to be imposed, e.g. that temperatures on the surface of the block are measurable. Secondly, the models are subject to Optimal Control Problems (OCP), where an optimal input function, meaning the temperature at the boundaries, is calculated in order to either optimally freeze or thaw blocks of foodstuff. This is done for open loop Optimal Control (OOC), which holds for perfect knowledge of the process with no measurement and estimation disturbances. Furthermore, closed loop Model Predictive Control (MPC) is applied, where measurement / estimation errors as well as discrepancies between the model and real process are taken into account. In Part IV experimental results for a freezing process in a horizontal plate freezer and a thawing process in a rebuilt horizontal plate freezer adapted for thawing purposes (plate thawer) are shown. Both of these experiments have been conducted at Matis Food Research in Reykjavik, Iceland. The freezing experiments were conducted with a rectangular tray made of aluminium, which was placed in between the plate freezer walls and filled with tap water. Temperature loggers were placed in several positions inside the tray to log the temperature during phase change from liquid to solid. Ammonia was used as the refrigerant in the plate freezer. For the thawing process the same tray was used. Blocks of frozen headed and gutted (H/G) cod were placed inside the tray and between the walls of the rebuilt plate freezer. The medium to thaw the fish blocks was tap water. Temperature loggers were attached to the fish blocks, namely in the center, half-way to the center and just below the surface. In Part V the thesis is closed with the conclusion and an outlook on future work.

Publication: Accepted for publication in the International Journal of Control, Taylor & Francis Group

Authors: Christoph Josef Backi, Jan Dimon Bendtsen, John Leth, Jan Tommy Gravdahl

Title: A heat equation for freezing processes with phase change: Stability analysis and applications

Abstract: In this work the stability properties as well as possible applications of a partial differential equation (PDE) with state-dependent parameters are investigated. Among other things, the PDE describes freezing of foodstuff, and is closely related to the (Potential) Burgers' Equation. We show that for certain

forms of coefficient functions, the PDE converges to a stationary solution given by (fixed) boundary conditions that make physical sense. These boundary conditions are either symmetric or asymmetric of Dirichlet type. Furthermore we present an observer design based on the PDE model for estimation of inner-domain temperatures in block-frozen fish and for monitoring freezing time. We illustrate the results with numerical simulations.

Publication: Submitted to Journal of Food Engineering October 2015

Authors: Christoph Josef Backi

Title: Methods for (industrial) thawing of fish blocks - a review

Abstract: In this concise review several methods for (industrial) thawing of fish are presented. These methods can be divided into two principal types, namely the ones that provide heat to the frozen fish only via its boundaries, and the ones that generate heat also in the frozen fish's inner domain. Both types come with advantages and disadvantages; however, the latter types are generally not (yet) suitable for industrial large-scale operation. The theory, functional principles and advantages / disadvantages will be highlighted in this work. In addition, an outlook on future developments as well as proposals for further research will be provided.

Publication: To be submitted

Authors: Christoph Josef Backi, John Leth, Jan Tommy Gravdahl

Title: Optimal boundary control for a contact thawing process for foodstuff

Abstract: In this work an approach for thawing blocks of foodstuff, in particular fish, is introduced. The functional principle is based on plate freezer technology, which has been used in industry for decades. The aim of this work is to describe the temperature dynamics of this thawing process by means of partial differential equations (PDEs) and control the boundary conditions in an optimal way. The PDE describing the temperature dynamics is based on the diffusion equation with state-dependent parameter functions.

Publication: In Proceedings of the 1st Conference on Modelling, Identification and Control of Nonlinear Systems (MICNON 2015), Saint-Petersburg, Russia, 2015

Authors: Christoph Josef Backi, Jan Dimon Bendtsen, John Leth, Jan Tommy Gravdahl

Title: Stability properties of a heat equation with state-dependent parameters and asymmetric boundary conditions

Abstract: In this work the stability properties of a partial differential equation (PDE) with state-dependent parameters and asymmetric boundary conditions are investigated. The PDE describes the temperature distribution inside foodstuff, but can also hold for other applications and phenomena. We show that the PDE converges to a stationary solution given by (fixed) boundary conditions, which explicitly diverge from each other. Numerical simulations illustrate the results.

Publication: Presented at the 19th Nordic Process Control Workshop, Trondheim, Norway, 2015

Authors: Christoph Josef Backi, Jan Tommy Gravdahl

Title: A reduced observer design for a freezing process in plate freezers

Abstract: In this work we present a reduced observer design for a freezing process. The model underlying the observer represents the dynamics of temperature $T(t,x,y)$ in a block of foodstuff and is based on a partial differential equation (PDE). In the following we leave out the explicit dependency of T on t , x and y . The PDE is the diffusion equation with temperature-dependent parameters $c(T)$ $\rho(T)$ $T_t = [\lambda(T) T_x]_x + [\lambda(T) T_y]_y$, where $c(T)>0$ denotes the specific heat capacity, $\rho(T)>0$ indicates the density and $\lambda(T)>0$ represents the thermal conductivity of the good to be frozen. We can rewrite the diffusion equation into $T_t = \kappa(T) [T_x^2 + T_y^2] + k(T) [T_{xx} + T_{yy}]$, which represents a nonlinear heat equation with the two parameters $\kappa(T) = \lambda(T)_T / [c(T) \rho(T)]$ and $k(T) = \lambda(T) / [c(T) \rho(T)]$. In phase change problems, here in particular for freezing, the phenomenon of thermal arrest caused by the presence of latent heat of fusion has to be regarded. This means that at the freezing point T_F the temperature remains constant until the latent heat of fusion is removed from the good to be frozen. Only then

the temperature can drop below the freezing point. Since the nonlinear heat equation does not model this phenomenon, it has to be imposed to the model. We do this by using the so called apparent heat capacity method, which basically overestimates the specific heat capacity $c(T)$. This has the effect that heat transfer in a neighbourhood around the freezing point $T_F \pm \Delta T$ becomes very low, leading to a very slow decay in temperature as well. In an earlier work we have designed an observer for the aforementioned nonlinear heat equation as an Extended Kalman Filter (EKF). The results showed good transient behavior and that inner-domain temperatures can be correctly estimated. However, real-time applicability could not be guaranteed. In the present work we show that by designing a reduced observer based on an EKF the states of the process modelled by the nonlinear PDE still can be correctly estimated for the chosen set of measurements. The reduced design is obtained by defining parameters such that the nonlinear part $\kappa(T) [T_x^2 + T_y^2]$ becomes zero for the observer model. This represents a first step towards real-time applicability, as the computational effort is reduced. Robustness is indicated by explicitly adding white Gaussian noise to the measurement signals. In addition, the observer parameters $\kappa(T)$ and $k(T)$ and the region around the freezing point $T_F \pm \Delta T$ are chosen to be double the size compared to those of the process running in parallel to the observer. Furthermore we show that performance can be improved by introducing temperature-dependent, quasi-adaptive observer covariance matrices. These matrices, however, are not temperature-dependent over the whole temperature range, but change values after a set of measured temperatures crosses a lower bound close to the freezing point (switching). All theoretical results are highlighted by numerical computations, where we conduct comparative studies between the earlier developed EKF based on the nonlinear PDE and the reduced observer design.

Publication: In Proceedings of the 2014 IEEE Multi-Conference on Systems and Control, Antibes, France, 2014

Authors: Christoph Josef Backi, Jan Dimon Bendtsen, John Leth, Jan Tommy Gravdahl

Title: Estimation of inner-domain temperatures for a freezing process

Abstract: In this paper a state observer for a distributed parameter system (DPS) with nonconstant parameter functions is presented. The DPS describes the freezing of foodstuff in vertical plate freezers and is a nonlinear heat equation. The observer is based upon the Extended Kalman Filter, meaning that the nonlinear heat equation has been discretized in the spatial domain before designing the observer. We show that the observer is robust with respect to perturbations of parameter functions and noisy measurement signals and that the inner-domain temperatures can be correctly estimated.

Publication: In Proceedings of the 19th IFAC World Congress, Cape Town, South Africa, 2014

Authors: Christoph Josef Backi, Jan Dimon Bendtsen, John Leth, Jan Tommy Gravdahl

Title: The nonlinear heat equation with state-dependent parameters and its connection to the Burgers' and the potential Burgers' equation

Abstract: In this work the stability properties of a nonlinear partial differential equation (PDE) with state-dependent parameters is investigated. Among other things, the PDE describes freezing of foodstuff, and is closely related to the (Potential) Burgers' Equation. We show that for certain forms of coefficient functions, the PDE converges to a stationary solution given by (fixed) boundary conditions that make physical sense. We illustrate the results with numerical simulations.

Publication: In Proceedings of the 21st Mediterranean Conference on Control and Automation, Chania, Greece, 2013

Authors: Christoph Josef Backi, Jan Tommy Gravdahl, Esten Ingar Grøtli

Title: Nonlinear observer design for a Greitzer compressor model

Abstract: In this paper two different observers for a nonlinear compressor model have been developed and compared: A nonlinear observer based on a circle criterion design and an Extended Kalman Filter. Both of these observers were implemented together with linear control strategies in order to (surge-)control the nonlinear Greitzer compressor model. The newly developed nonlinear observer is a full state observer providing local asymptotic stability results. Compared to the Extended Kalman Filter, the nonlinear observer showed itself at least equivalent, even superior for open-loop estimation.

Publication: In Proceedings of the 2013 Australian Control Conference, Perth, Australia, 2013
Authors: Christoph Josef Backi, Jan Tommy Gravdahl
Title: Optimal boundary control for the heat equation with application to freezing with phase change

Abstract: In this paper an approach for optimal boundary control of a parabolic partial differential equation (PDE) is presented. The parabolic PDE is the heat equation for thermal conduction. A technical application for this is the freezing of fish in a vertical plate freezer. As it is a dominant phenomenon in the process of freezing, the latent heat of fusion is included in the model. The aim of the optimization is to freeze the interior of a fish block below -18 C in a predefined time horizon with an energy consumption that is as low as possible assuming that this corresponds to high freezing temperatures.

Publication: Presented at the 18th Nordic Process Control Workshop, Oulu, Finland, 2013
Authors: Christoph Josef Backi, Jan Tommy Gravdahl
Title: Optimal Neumann boundary control for a freezing process with phase change

Abstract: The system studied in this paper is a model of heat exchange phenomena, known as the heat equation. This is a parabolic partial differential equation (PDE). The application is the freezing of a fish block in a vertical plate freezer where liquid ammonia (NH₃) at minimal 235 K is used as the cooling medium. A pump forces the ammonia through the plate freezer, where it partly vaporizes due to the heat taken out from the fish block. The amount of heat added to the ammonia is removed in a compression/condensation/throttling - process with the consequence that the whole process is a cycle process. The freezing of fish in a vertical plate freezer is a thermodynamical process where certain thermodynamical phenomena hold. Fish consists to a large amount of water and when water undergoes phase change while crossing the freezing point (liquid to solid state) one can observe that for a certain period of time the temperature will remain constant at the freezing point. Although not observable by measurement due to the constant temperature, there is still energy removed from the fishblock, the so called latent heat of fusion. Physically, latent heat of fusion is a hidden amount of energy that is needed to break the grid structure of the solid phase when melting ice. This phenomenon is not directly modeled in the standard heat equation and thus it is modeled by adapting the thermodynamical properties \specific heat capacity c_p and thermal conductivity λ of the fish around the freezing point. The approach of solving the optimal control problem (OCP) with Neumann boundary conditions (defining heat flow at the boundaries) is a two-dimensional spatial discretization of the fish block leading to a set of ordinary differential equations (ODEs). For every discretization-step in y -direction a new input function u_i is defined which acts exclusively in x -direction. At $y=0$ (top of the fishblock) there is heat exchange with the surrounding air due to convection, whereas at $y=H$ (bottom of the fishblock) there is perfect isolation assumed. Both, convection with air and perfect isolation happen along the x -direction. To solve the OCP the software package ACADO for MATLAB developed by Moritz Diehl and coworkers has been used. The bounds on the OCP are the discretized system equations and the maximal and minimal temperatures that the fish block can tend to: Due to basic thermodynamical laws it cannot become warmer than the surrounding temperature and not colder than the temperature of the ammonia cooling it down. Furthermore, bounds on the input function defining maximal and a minimal heat flow as well as terminal state constraints are introduced. It has to be mentioned that the input functions are chosen as the quotient of heat flow q and thermal conductivity of ammonia λ_{NH_3} , where the heat flow q can be exchanged by the product of the massflow of ammonia m_{NH_3} and the enthalpy difference of the ammonia h_{NH_3} . This is valid because the same amount of heat that leaves the fish gets absorbed by the ammonia.

Publication: In Proceedings of the 17th Nordic Process Control Workshop, Copenhagen, Denmark, 2012
Authors: Christoph Josef Backi, Jan Tommy Gravdahl
Title: Modeling of the Freezing Process for Fish in Vertical Platefreezers

Abstract: Energy-efficiency is one of the big issues of the 21st century. Due to the limited resources of primary energy carriers and their environmental load, a higher effectiveness for their use has to be achieved. Even small improvement in models, observers and/or control-strategies can have a large impact on consumption of energy carriers. The system we are looking at is a fishing vessel (trawler). The overall aim is therefore, to reduce energy consumption and, at the same time, preserve or even enhance fish quality. The

vessel is driven by a (diesel-) main engine, which produces electricity. All of the vessel's consumers, such as electric propulsion motors, freezing units, processing units, cooling pumps, ship operation equipment and other facilities are powered by electric energy from the main engine. Besides the propulsion motors, the freezing units are the biggest energy consumers on board. The caught fish shall, after having been processed (blooded, headed and gutted), be frozen as fast as possible. The process, that is used to freeze the fish, is a vapor-compression refrigeration circle process run with ammonia (NH₃). The ammonia flows through the freezer's plates, cools them down very strongly (-38 C) and due to direct contact, the fish gets frozen. The model, that is taken for simulating the temperature distribution throughout the fish block with thickness L, is the one dimensional heat-equation, a linear partial differential equation: $\rho(T) c(T) T_t = \lambda(T) T_{xx}$. It has to be noticed, that the parameters $\rho(T)$, $c(T)$ and $\lambda(T)$ change with temperature. Simplified, the fish can be considered as a thermodynamical alloy of many basic components, such as water/ice, protein, fat, carbohydrates and ash. The parameters can therefore be calculated by $\rho(T) = \sum_i \rho_i(T) x_i$, $c(T) = \sum_i c_i(T) x_i$ and $\lambda(T) = \sum_i \lambda_i(T) x_i$, where $\rho_i(T)$, $c_i(T)$ and $\lambda_i(T)$ correspond to component i and x_i represents the mass fraction of component i. Note, that not 100 % of the water in the fish gets frozen in the temperature range, we are looking at. At -30 C only about 90 % of the water is frozen. The reason for this is, that, when freezing, solutes remain in the liquid phase, lowering its freezing point. Just at about -70 C all the water can be considered as frozen. A phenomenon, that has to be considered due to the large fraction of water present in fish (60 % - 80 %), is the latent heat of fusion. This means, that there will occur heat transfer at the freezing point without lowering the temperature. This can be explained by energy storage present in the formation of water molecules. This energy has to be removed in order to enable water molecules to nucleate and ice crystals to form and grow. Ice crystal growth has a big influence on quality of the product. Dependent on the speed of freezing, ice crystal sizes differ. Slow freezing results in large ice crystals and fast freezing in small ice crystals, respectively. Large ice crystals emerge when extracellular freezing happens prior to intracellular freezing, which disrupts the thermodynamical equilibrium. As a consequence, fluid is drawn from the inside of a cell to the outside, causing destruction of cell walls and thus reducing the quality. In this work, we present a mathematical model for the temperature of fish in vertical plate freezers. The temperature distribution will be linked to a quality measure. This model will be useful when designing control strategies for the on-board energy system and, at the same time, monitoring fish quality.

6 Conclusions

- Studies on short time live storage of fish before killing gave the following results:
 - When towing times are short and catches are small a survival of 50-80 % was found for cod (density of fish in the storage tank varied from 120 to 550 kg/m³)
 - The fishing depth has influence on survival rate.
 - The stress level of the fish was lower straight after catch than after storage in live holding tanks onboard (not always significant differences)
 - Less blood was found in fillets from live stored fish and fish processed straight after catch compared to commercial processed fish.
- Studies on electro stunning of fish gave the following results:
 - Voltage of 40 V DC is enough to achieve satisfactory immobilizing and easier handling of catch in connection with further processing (bleeding/gutting/heading) for cod, haddock and saithe.
 - Three rows of electrodes on the stunner (current load for 4 - 6 seconds) is enough to achieve satisfactory immobilization.
 - Electro stunning of saithe lead to broken backbone and bloodspots on 10 to 40 % of the fish.
- Studies on freezing of cod gave the following results:
 - Pre-rigor cod frozen in a magnetic field (Cell Alive System) gave minimal differences in quality compared to traditional tunnel freezing and freezing in a cold room, in spite of differences in freezing rate.
 - The mechanism for the freezing of fish in the magnetic field, under the current conditions, appeared to be similar to that of traditional freezing methods.
- Studies on chilling of cod and haddock onboard gave the following results:
 - Cod and haddock stored in slurry had a different microstructure and different water distribution, measured by low field NMR, than those stored in flake ice.
 - Differences in color and QIM-score were found for haddock stored under the two conditions.

Logging of operational data gave the following results:

- Software for acquisition and storage of operational data has been developed.
- Systems for acquisition and storage of operational data, as well as transfer of the data to an on-shore server, have been installed on-board two trawlers.
- Software for efficient analysis of operational data has been developed and used to generate operational profiles.

Model development gave the following results:

- Methods and models for simulating catch handling processes have been developed, along with proof-of-concept software that demonstrates their practical use.
- Discrete event simulation seems to be a very suitable method for simulating and evaluating fish processing lines, though more work needs to be done with regards to model quality and validation.

Acquiring high-quality data about catch handling processes for modelling purposes is difficult and labour-intensive. Future experiments should be designed to focus more on individual processes and less on the whole line, and should aim to keep better track of the "human factors" that add noise and affect the outcome.

References

- Abedini, S., Kaku, M., Kawata, T., Koseki, H., Kojima, S., Sumi, H., Motokawa, M., Fujita, T., Ohtani, J., Ohwada, N., and Tanne, K. 2011. Effects of cryopreservation with a newly-developed magnetic field programmed freezer on periodontal ligament cells and pulp tissues. *Cryobiol.* 62: 181-187.
- Akse, L., Joensen, S., Tobiassen, T., Midling, K.Ø., & Eilertsen, G. (2005) Fangsthåndtering på store snurrevad fartøy. Del 1: Bløtdømming av torsk. Fiskeriforskning rapport 9/2005.
- Alizadeh E, Chapleau N, deLamballerie M, LeBail A (2007) Effect of freezing and thawing processes on the quality of Atlantic salmon (*Salmo salar*) fillets. *J. Food Sci.* 72: E279-E284.
- Andersen, C.M., Rinnan, Å. (2002) Distribution of water in fresh cod. *Lebensmittel-Wissenschaft und Technologie.* 35, 687-696.
- Angsupanich K, Ledward DA (1998) High pressure treatment effects on cod (*Gadus morhua*) muscle. *Food Chem.* 63: 39-50.
- Anonym (1977) Quick freezing of fish. Torry Advisory Note No. 27, Torry Research Station, Aberdeen, UK.
- Aubourg SP, Gallardo JM (2005) Effect of brine freezing on the rancidity development during frozen storage of small pelagic fish species. *Eur. Food Res. Technol.* 220: 107-112.
- Aursand, I.G., Veliyulin, E., Böcker U., Rustad, T. and Erikson, U. (2009) Water and salt distribution in Atlantic salmon (*Salmo salar*) studied by low-field ¹H NMR, ¹H and ²³Na MRI and light microscopy – Effects of raw material quality and brine salting. *J Agric. Food Chem.* 57, 46-54.
- Bejarano Wallens CO, Venetucci J (1995) Emerging freezing technologies. *Food Processing – Recent Developments*, pp 227-240, Elsevier.
- Bello, R. A.; Luft, J. H.; Pigott, G. M., Improved histological procedure for microscopic demonstration of related changes in fish muscle-tissue structure during holding and freezing. *J. Food Sci.* 1981, 46, 733-&.
- Botta, J.R., Bonnell, G. & Squires, B.E. (1987) Effect of method of catching and time of season on sensory quality of fresh Atlantic cod (*Gadus morhua*). *J. Food Sci.* 52, 928-931, 938.
- Botta, J.R., Squires, B.E. & Johnson, J. (1986) Effect of bleeding/gutting procedures on the sensory quality of fresh raw Atlantic cod (*Gadus morhua*). *Can. Inst. Food Sci. Technol. J.* 1986; 19: 186-190.
- Bøknæs N, Guldager HS, Østerberg C, Nielsen J (2001) Production of high-quality frozen cod (*Gadus morhua*) fillets and portions on a freezer trawler. *J. Aquatic Food Prod. Technol.* 10: 33-47.
- Çelik, V. & Arcaklioglu, E. 2005. Performance maps of a diesel engine. *Applied Energy*, 81(3): 247-259.
- Chevalier D, Sentissi M, Havet M, LeBail A (2000b) Comparison of air-blast and pressure shift freezing on Norway lobster quality. *J. Food Sci.* 65: 329-333.
- Chevalier D, Sequeira-Munoz A, LeBail A, Simpson BK, Ghoul M (2000a) Effect of pressure shift freezing, ABF and storage on some biochemical and physical properties of turbot (*Scophthalmus maximus*). *Lebens Wissens Technol.* 33: 570-577.
- Chevalier, D., Sequeira-Munoz, A., Le Bail, A., Simpson, B.K., and Ghoul, M. 2001. Effect of freezing conditions and storage on ice crystal and drip volume in turbot (*Scophthalmus maximus*). *Evaluation of pressure shift vs. air-blast freezing.* *Innov. Food Sci. Emerg. Technol.* 1: 193-201.
- Dempsey P, Bansal P (2012) The art of air blast freezing: Design and efficiency considerations. *Appl. Thermal Eng.* 41: 71-83.
- Digre, H., Jes Hansen, U., and Erikson, U. 2010. Effect of trawling with traditional and 'T90' trawl codends on fish size and on different quality parameters of cod *Gadus morhua* and haddock *Melanogrammus aeglefinus*. *Fish. Sci.* 76: 549-559.
- Digre, H., Erikson, U., Misimi, E., Lambooi, B. & van de Vis, H. (2009) Electrical stunning of farmed Atlantic cod *Gadus morhua* L.: Comparison of an Industrial and Experimental Method. Accepted in *Aquaculture Research*.
- Ellingsen H., Aanonsen S. A. 2005. Energy use in the Norwegian fishing industry - Environmental consequences of alternative energy carriers. 2nd International Conference on Life Cycle Management, Barcelona, 5-7 September.
- Erikson, U., Misimi, E., Schei, M., Digre, H., Dahle, S.W. & Grimsmo, L. (2009) Superfersk fisk med riktig kvalitet: Rapport fra tokt med M/S Skaidi 21.-31. november 2008. SINTEF report A095060 – unrestricted. ISBN 978-82-14-04921-3.
- Esaiassen, M., Nilsen, H., Joensen, S., Skjerdal, T., Carlehøg, M., Eilertsen, G., Gundersen, B. & Elvevoll, E. (2004) Effects of catching methods on quality changes during storage of cod (*Gadus morhua*). *Lebensmittel-Wissenschaft und-Technologie* 37, 643-648.
- Fernández PP, Otero L, Guignon B, Sanz PD (2006) High-pressure shift freezing versus high-pressure assisted freezing: Effects on microstructure of a food model. *Food Hydrocolloids* 20: 510-522.
- Fikiin AG (1992) New method and fluidized water system for intensive chilling and freezing of fish. *Food Control* 3: 153-160.

- Grimaldo, E., Herrmann, B. & Vollstad, J. (2013) Tokrapport: Seleksjonsforsøk med 55mm enkeltrist i firepanelkonstruksjon. SINTEF report A24000 – unrestricted. ISBN 978-82-14-05569-6.
- Hardarson, V. 1996. Matvarers termofysiske egenskaper og deres betydning ved dimensjonering av frysetunneler. Dr.ing.-avhandling 1996:23 NTH, 141 pp.
- Hattula, T., Luoma, T., Kostiainen, R., Poutanen, J., Kallio, M. & Suuronen, P. (1995) Effects of catching method on different quality parameters of Baltic herring (*Clupea harengus* L.). *Fish. Res.* **23**, 209 – 221
- Hsieh, C.-W., Lai, C.-H., Lee, C.-H., and Ko, W.-C. 2011. Effects of high-voltage electrostatic fields on the quality of tilapia meat during refrigeration. *J. Food Sci.* **76**: M312-M317.
- Huss, H.H., and Asenjo, I. 1976. Some factors influencing the appearance of fillets from whitefish. *Technological Laboratory – a report. Ministry of Fisheries, Lyngby, Denmark*, 8 p.
- Jensen, K.N., Guldager, H.S., Jørgensen, B.M. (2002) Three-way modelling of NMR relaxation profiles from thawed cod muscle. *Journal of Aquatic Food Product Technology*, **11**, 201–214.
- Jepsen, S.M., Pedersen, H.T., Engelsen, S.B. (1999) Application of chemometrics to low-field ¹H NMR relaxation data of intact fish flesh. *Journal of the Science of Food and Agriculture*, **79**, 1793–1802.
- Jolliffe, I.T. (1997) *Principal Component Analysis*; Springer-Verlag: Berlin, Germany.
- Jonatansson, E. & Randhawa, S. U. (1986) A network simulation model of a fish processing facility. *Simulation*, **47**: 5-12.
- Jonatansson, E. & Randhawa, S. U. (1986) A simulation based decision model for a fish processing facility. *Computers & Industrial Engineering*, **11**: 406-410.
- Kelly, T.R. 1969. Discolouration in sea-frozen fish fillets. In *Freezing and Irradiation of Fish*. Edited by R. Kreuzer. Fishing News (Books), London. pp. 64-67.
- Kesgin, U. 2003. Study on prediction of the effects of design and operating parameters on NOx emissions from a leanburn natural gas engine. *Energy Conversion and Management*, **44**(6): 907-921.
- Kesgin, U. 2004. Genetic algorithm and artificial neural network for engine optimisation of efficiency and NOx emission. *Fuel*, **83**(7-8): 885-895.
- Kaku, M., Kawata, T., Abedini, S., Koseki, H., Kojima, S., Sumi, H., Shikata, H., Motokawa, M., Fujita, T., Ohtani, J., Ohwada, N., Kurita, M., and Tanne, K. 2012. Electric and magnetic fields in cryopreservation: A response. *Cryobiol.* **64**: 304-305.
- Kalichevsky MT, Knorr D, Lillford PJ (1995) Potential food applications of high-pressure effects on ice-water transitions. *Trends Food Sci. Technol.* **6**: 253-259.
- Kolbe E, Kramer D (2007) *Planning for seafood freezing*. Fairbanks Alaska: Alaska Sea Grant Program, University of Alaska Fairbanks, 118 pp.
- Kobayashi, A., and Kirschvink, J.L. 2014. A ferromagnetic model for the action of electric and magnetic fields in cryopreservation. *Cryobiol.* **68**: 163-165.
- Lambelet, P., Renevey, F., Kaabi, C., Raemy, A. (1995) Low-field nuclear magnetic resonance study of stored or processed cod. *Journal of Agricultural and Food Chemistry*, **43**, 1462–1466.
- Lambooij E., Kloosterboer R.J., Gerritzen M.A. & van de Vis J.W. (2004) Head-only electrical stunning and bleeding of African catfish (*Clarias gariepinus*): assessment of loss of consciousness. *Animal Welfare* **13**, 71-76.
- LeBail A, Chevalier D, Mussa, DM, Ghouil M (2002) High pressure freezing and thawing of foods: a review. *Int. J. Refrig.* **25**: 504-513.
- Leygonie C, Britz TJ, Hoffman LC (2012) Impact of freezing and thawing on the quality of meat: Review. *Meat Sci.* Lovatt, S. J., Loeffen, M. P. F., & Cleland, A. C. 1998. Improved dynamic simulation of multi-temperature industrial refrigeration systems for food chilling, freezing and cold storage. *International Journal of Refrigeration*, **21**(3): 247-260.
- Li B, Sun D-W (2002) Novel methods for rapid freezing and thawing of foods – a review. *J. Food Eng.* **54**: 175-182.
- Lillford, P.J., Clark, K.H., Jones, D.V. (1980) Distribution of water in heterogeneous foods and model systems. In *Water in Polymers*; Rowland, S.P., Ed.; American Chemical Society: Washington, DC, 177-195.
- Løje, H., Green Petersen, D., Nielsen, J., Jørgensen, B.M., Jensen, K.N. (2007) Water distribution in smoked salmon. *Journal of the Science of Food and Agriculture*, **87**, 212–217.
- MacCallum, W.A., Jaffray, J.I., Churchill, D.N., and Idler, D.R. 1968. Condition of Newfoundland trap-caught cod and its influence on quality after single and double freezing. *J. Fish. Res. Bd. Can.* **25**: 733-755.
- Martens, H., Martens, M. (2001) *Multivariate analysis of quality: an introduction*. Chichester, UK: John Wiley & Sons, Ltd.
- Martinsdóttir, E., and Magnússon, H. 2001. Keeping quality of sea-frozen thawed cod fillets on ice. *J. Food Sci.* **66**: 1402-1408.
- McDonald, I., and Jones, N.R. 1976. Control of thaw rigor by manipulation of temperature in cold store. *J. Food Technol.* **11**: 69-71.
- Nicholson FJ (1982) The freezing time of fish. *Torry Advisory Note No. 62*, Torry Research Station, Aberdeen, UK, 7pp.

- Næs, T., Isaksson, T., Fearn, T., Davies, D. (2002) A user-friendly guide to multivariate calibration and classification. Chichester, UK: NIR Publications.
- Ohshima T, Ushio H, Koizumi C (1993) High-pressure processing of fish and fish products. *Trends Food Sci. Technol.* 4: 370-375.
- Olsen, S.H., Joensen, S., Tobiassen, T., Heia, K., Akse, L., and Nilsen, H. 2014. Quality consequences of bleeding fish after capture. *Fish. Res.* 153: 103-107.
- Pham, Q. T. 2006. Modelling heat and mass transfer in frozen foods: a review. *International Journal of Refrigeration*, 29(6): 876-888.
- Provencher, S. W. (1982) A constrained regularization method for inverting data represented by linear algebraic of integral equations. *Computer Physics Communications*, 27, 213–227.
- Rakopoulos, C. D. & Giakoumis, E. G. 2006. Comparative first- and second-law parametric study of transient diesel engine operation. *Energy*, 31(12): 1927-1942.
- Randhawa, S. U. (1994) Integrating simulation and optimization: an application if fish processing industry. *Proceedings of the 26th Winter Simulation Conference*: 1241-1247.
- Randhawa, S. U. & Bjarnason, E. T. (1995) A decision aid for coordinating fishing and fish processing. *European journal of operational research*, 81: 62-75.
- Robb D.H.F. & Roth B. (2003) Brain activity of Atlantic salmon (*Salmo salar*) following electrical stunning using various field strengths and pulse durations. *Aquaculture* 216, 363-369.
- Rotabakk, T.B., Skipnes, D., Akse, L., and Birkeland, S. 2011. Quality assessment of Atlantic cod (*Gadus morhua*) caught by longlining and trawling at the same time and location. *Fish. Res.* 112: 44-51.
- Roth B. 2003. Electrical Stunning of Atlantic salmon (*Salmo salar*). Dr.scient thesis. Department of Fisheries and Marine Biology, University of Bergen, Bergen, Norway. 47 p.
- Slagstad, D. & McClimans, T. A. (2005) Modeling the ecosystem dynamics of the Barents Sea including the marginal ice zone: I. Physical and chemical oceanography, *Journal of Marine Systems*, 58: 1-18
- Steen, C.; Lambelet, P. Texture changes in frozen cod mince measured by low-field nuclear magnetic resonance spectroscopy. *J. Sci. Food Agric.* **1997**, 75, 268-272.
- Stefanopoulou, A. & Smith, R. 2000. Maneuverability and smoke emission constraints in marine diesel propulsion. *Control Engineering Practice*, 8(9): 1023-1031.
- Suzuki, T., Takeuchi, Y., Masuda, K., Watanabe, M., Shirakashi, R., Fukuda, Y., Tsuruta, T., Yamamoto, K., Koga, N., Hiruma, N., Ichioka, J., and Takai, K. 2009. Experimental investigation of effectiveness of magnetic field on food freezing process. *Trans. Jap. Soc. Refrig. Air Cond. Eng.* 26: 371-386 (in Japanese).
- Takeda, F. 1991. The effect of a magnetic field on water treatment. *Water Purif. Liq. Wastes Treatm.* 32: 515-517 (in Japanese).
- Thybo, A.K., Bechmann, I.E., Martens, M., Engelsen, S.B. (2000) Prediction of sensory texture of cooked potatoes using uniaxial compression, near infrared spectroscopy and low field H-1 NMR spectroscopy. *Food Science and Technology, Lebensmittel-Wissenschaft und Technologie*, 33, 103-111
- Thygesen, L.G., Thybo, A.K., Engelsen, S.B. (2001) Prediction of sensory texture quality of boiled potatoes from low field 1H NMR of raw potatoes. The role of chemical constituents. *Food Science and Technology, Lebensmittel-Wissenschaft and Technologie*, 34, 469-477
- Valdimarsson, G., Matthiasson, A. & Stefansson, G. (1984) The effect of on board bleeding and gutting on the quality of fresh, quick frozen and salted products. In: *Fifty Years of Fisheries Research in Iceland*. A. Moller (Ed.), Reykjavik, Iceland, pp 61-72
- Vyncke, W. 1983. Shelf life of thawed cod fillets kept in ice. *Lebensm. Unters. Forsch.* 177: 19-21.
- Wang, L., Lee, D. J., Lee, W. J., & Chen, Z. 2008. Analysis of a novel autonomous marine hybrid power generation/energy storage system with a high-voltage direct current link. *Journal of Power Sources*, 185(2): 1284-1292.
- Wowk, B. 2012. Electric and magnetic fields in cryopreservation. *Cryobiol.* 64: 301-303.
- Özyurt, G., Özogul, Y., Özyurt, C.E., Polat, A., Özogul, F., Gökbulut, C., Ersoy, B. & Küley, E. (2007) Determination of the quality parameters of pike perch *Sander lucioperca* caught by gillnet, longline and harpoon in Turkey. *Fish. Sci.* 73: 412-420.



Technology for a better society

www.sintef.no