

Oil-Free R744 systems for Industrial/Commercial Applications

HAFNER A.^(*); NEKSÅ P.^(*), LADAM Y.^(*), EIKEVIK T.M.^()**

^(*) SINTEF Energy Research,
7465 Trondheim, Norway
Armin.Hafner@sintef.no

^(**) Norwegian University of Science and Technology
7491 Trondheim, Norway

ABSTRACT

Today's refrigeration systems have to use a defined portion of oil in order to provide lubrication of mechanical moving parts in the compressors. This oil is mainly added into the compressor but is transported with the working fluid into the system, so a not negligible amount is pumped around in the system.

The benefits of oil-free R744 systems compared to conventional system are evaluated for different application like: commercial refrigeration, transport refrigeration, onboard Refrigerated Sea Water (RSW) production and industrial heat pumping systems. In general the installation costs are reduced, due to much simpler oil-free system architecture.

The Life Cycle Costs (LCC) of an oil-free system are reduced compared to conventional systems due to a reduction in servicing and maintenance efforts and the improved system performance which leads to more energy efficient operation.

The development of a hermetic oil-free compressor is part of the CREATIV project. A pilot compressor is developed, installed in the laboratory in 2011 and will be applied later on in some pilot applications.

1. INTRODUCTION

For common vapour compression systems, the role of lubricant oil is inevitable for the need to lubricate the sliding parts mainly inside the compressor in a refrigerating or heat pumping system. However, the oil is known to have several depreciating effects on the system performance.

In a typical Air-Conditioning or refrigeration system, a certain amount of lubricant oil migrates from the compressor into another part of the system, such as the evaporator, condenser, expansion device, and connecting piping. Beside the lubrication inside the compressor, lubricant oil has a negative impact on the system performance due to a significant reduction in heat transfer inside the heat exchangers. In addition, a complex and costly lubricant oil (return) management is required for industrial applications.

2. BENEFITS OF OIL FREE REFRIGERATION SYSTEM

2.1 Improved of heat transfer

The main argument for removing oil from the refrigeration system is its depreciating effect on the heat transfer properties of the refrigerant. Several studies investigate the effect of lubricant oil on the heat transfer coefficient of refrigerant fluids [Hamraeus et al. (1995), Thome (1995)]. It is found that effect of lubricant oil for pool boiling of conventional HFC refrigerants is quite complex, and the existing literature is ambiguous on this subject. However, the general opinion is that the lubricant oil will impair the heat transfer properties. For condensation, there is a more unified opinion that the lubricant oil reduces the heat transfer.

For natural refrigerants (especially R744/CO₂), the effect is clearer, and it well known that the lubricant oil has a significant depreciating effect on the heat transfer properties of both evaporation and supercritical cooling of CO₂.

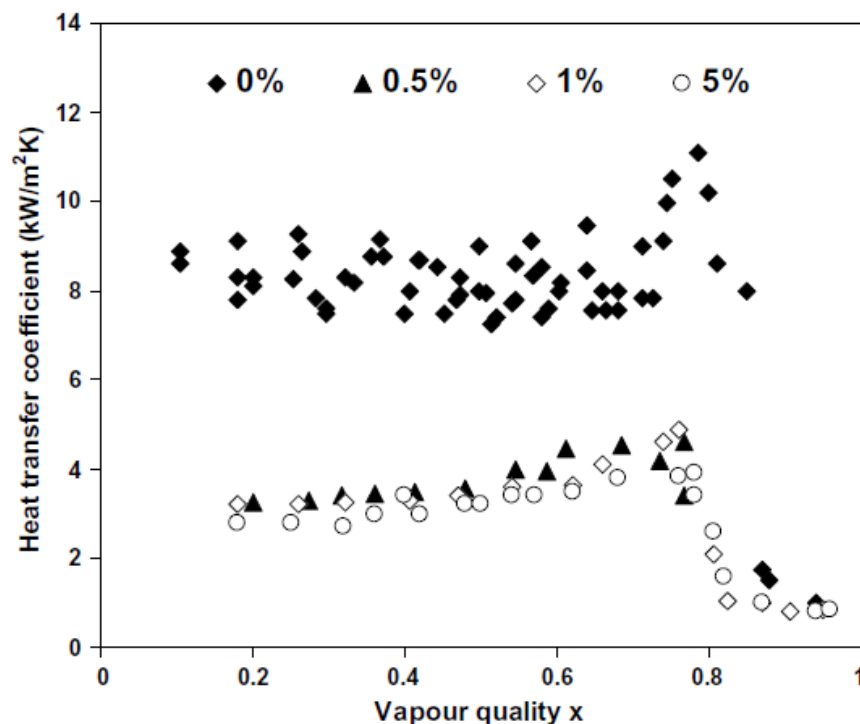

Figure 1: Effect of oil concentration on HTC of CO₂-PAG mixture at $G = 360 \text{ kg/m}^2 \text{ s}$, $T_{\text{sat}} = 10 \text{ }^\circ\text{C}$ and $q = 9 \text{ kW/m}^2$ [Dang et al.]

Figure 1 shows difference in heat transfer coefficients for evaporation CO₂ with different oil concentrations. These results are supported by several other publications [Gao; Dang and Koyama].

As discussed above, the heat transfer properties of refrigerant are usually impaired by the presence of lubricant oil. This means that oil free systems can utilize smaller heat exchangers for an equal capacity than conventional systems, or increase the system performance, due to lower temperature differences and less pressure drop inside the heat exchanger. Figure 2 indicates how different oil fractions can affect the required length of an evaporator tube for same evaporation temperature and duty. If the evaporator size is given, for a required cooling capacity the evaporation temperature will be lower the more lubricant is circulated with the refrigerant, as shown in Figure 3.

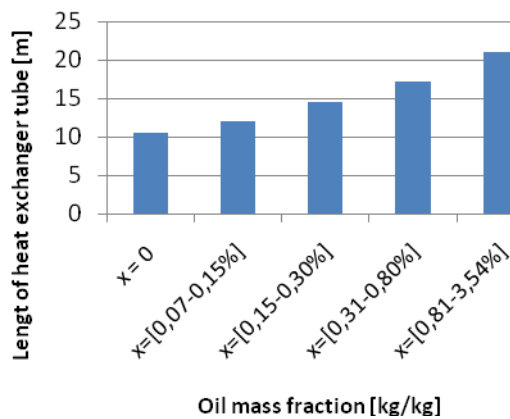

Figure 2: Effect on heat exchanger size

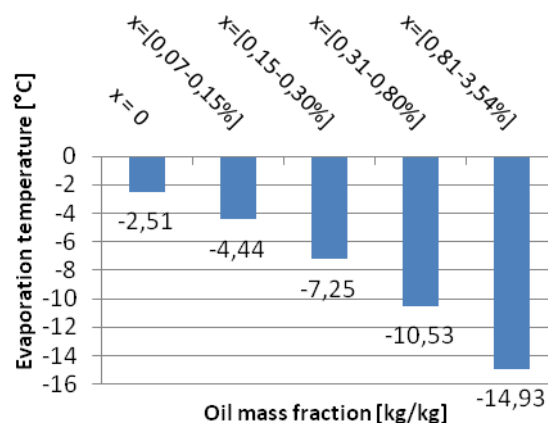

Figure 3: Effect on evaporation temperature

Benefit within the different application areas; commercial refrigeration, transport refrigeration, onboard RSW production and industrial heat pumping systems:

- Improved heat transfer reduces the necessary temperature difference between the heat exchanging fluids which lead to higher evaporating temperatures at equal capacities.
- The overall system performance increases and the operating cost (energy demand) are reduced which has a positive effect on the LCC.
- Periods with frost formation on the airside of evaporates can be reduced, due to higher evaporation temperatures.
- Compact and high performance heat exchangers can be realised when space is limited in transport on onboard installations.
- Improved controllability of the evaporator temperature, especially for the food transport sector and RSW where small temperature variations inside the refrigerated space are required.

2.2 Lower system complexity

The lubricant migration is trapped somewhere in the system and not returning to the compressor, this will both reduce the overall performance and affect the reliability (lifetime) of the compressor. Therefore it is necessary to implement an oil management (recovery) system. The design and complexity of the oil recovery system is dependent on the rest of the refrigeration process (design and refrigerant) and if the lubricant is soluble in the refrigerant or not. In addition to increased costs and system complexity, the oil management also often requires smaller diameter tubes to overcome the shear stress when carrying the oil in vertical tubes, which leads to higher pressure drops [Youbi-Idrissi *et al.*] and lower system efficiencies.

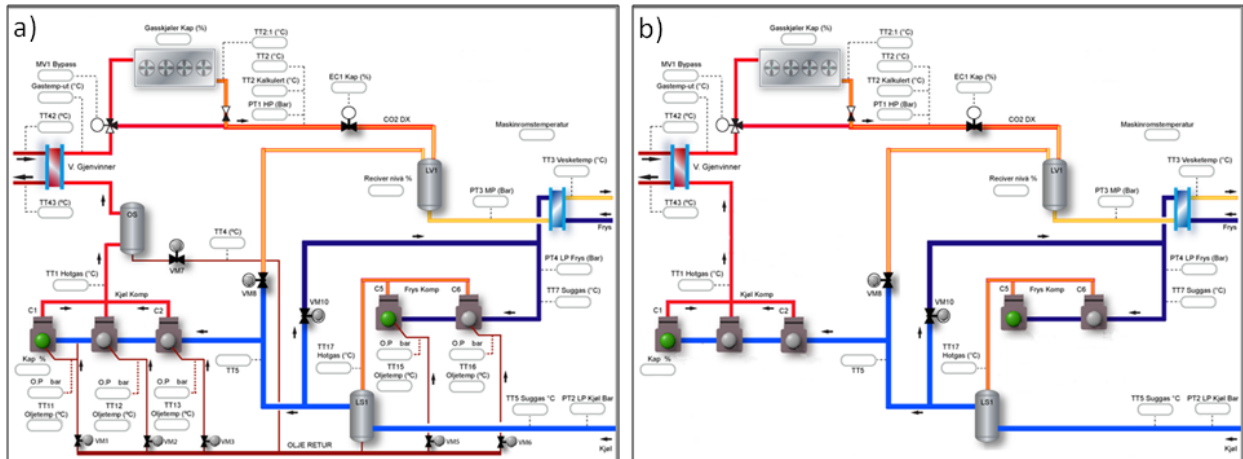

Figure 4: Typical R744 booster commercial refrigeration system. (ref: Kuldeteknisk AS)

- a) with oil lubrication and
- b) without oil (applying oil-free compressors).

Figure 4 a) and b) shows a comparison of how a P&ID would look for a R744 supermarket refrigeration system with and without the management of the lubricating oil. The entire lubricant recovery/return system can be removed (the brown circuit in Figure 4a), in this case, the system configuration will be much simpler and less costly. Especially the oil separator (OS) (after the high pressure compressors) is an expensive component which has to be integrated in current equipment which requires lubricants.

Benefit within the different application areas; commercial refrigeration, transport refrigeration, onboard RSW production and industrial heat pumping systems:

- Reduced installation cost, due to much simpler oil-free system architecture.
- Reduced system complexity leads to less system errors and system down periods, which are crucial and should not appear, due to the high value of the goods inside the refrigerated space.
- Lower LCC since no handling and control of the lubricant system is required, i.e. much simpler service of the systems.

2.3 Increase of maximum discharge temperature

In many cases (especially with ammonia systems) the presence of lubricant is limiting the compressor discharge temperature, since some lubricants decompose at temperatures between 100 °C and 200 °C (for natural working fluids, 120-140°C for HFC fluids). This means that systems applying oil free compressors can accept higher pressure ratios per compressor stage.

Table 1: Maximum temperatures for different lubricant types applied in systems with natural working fluids [Fuchs 2010]

Oil type	Max working temperature
PAG (Polyalkylene glycol)	160-180°C
POE (Polyolester)	200°C
PAO (Polyalpha-olefin)	180°C

Alkylbenzole	120-140°C
Mineral oil	100-120°C

Benefit within the different application areas; commercial refrigeration, transport refrigeration, onboard RSW production and industrial heat pumping systems:

- Increased discharge temperature range allows for simple system architecture, i.e. increase the operation range of the different compressor stages or reduce the number of necessary compressor stages for non design point operation ranges.
- At elevated ambient temperatures, compressor discharge temperatures above 200°C are sometimes accepted, if the design of the unit is adapted.

2.4 Decrease the minimum evaporating temperature

The absence of lubricant allows to enter new areas at operation temperatures below -40°C. As described by Yamaguchi et al. (2008) it is possible to operate a R744 refrigeration system even below the triple point (below -56°C). Ultra low temperature refrigeration technology is feasible by applying oil-free compressors.

Benefit within the different application areas; commercial refrigeration, transport refrigeration, onboard RSW production and industrial heat pumping systems:

- Low temperature refrigeration is possible without advanced additional equipment. i.e. simple implementation into R744 system architecture.
- Opens the possibility for production and storage of solid CO₂, as a cold storage (hour to hour / short term)

3. POTENTIAL COMPRESSOR TECHNOLOGIES

The main reason for adding oil in a refrigeration system is lubrication of the moving parts in the compressor and reduces leakages. In some cases like screw compressors, lubrication oil is also used to remove heat from the compressor.

Since the compressor is the component that utilizes the oil in a standard refrigeration system, it is also the component that needs most care when designing for an oil free system.

The main technical challenges for the design of oil free refrigeration compressors are:

- **Material / Coatings**
For “dry running” solutions, materials and coatings that allow relative movement and surface load without additional lubrication (e.g. graphite or Teflon). However, for applications where a long component lifetime is required “dry running” is not feasible.
- **Leakage losses**
When dry running is not possible, gaps and tolerances must be included between the moving parts of a compressor. This results in backflow and leakages, i.e. a reduction in the volumetric efficiency. This is especially challenging for systems with large pressure differences (e.g. R744 / CO₂).
- **Bearing technology**
Three main categories of (oil-free) bearings are available:
Rolling element bearings,
Magnetic bearings,
Fluid bearings.
- **Shaft Sealing**
For open compressor solutions, sealing’s which ensure the lowest possible leakage both during running and standstill must be applied.

Within the CREATIV project three potential designs for R744 oil-free compressors are identified: screw-, piston- and turbo compressors. For all these designs, vendors have developed concepts. Oil free turbo compressors are widely available mainly for low pressure differences. Some are implemented in refrigeration cycles, however mainly for large scale systems.

Focus is given to the development of a two stage radial turbo compressor in the range of 100 kW electrical power input. The main reasons for choosing this capacity range are; there are several applications where this size of turbo compressor could be applied and the available budget.

4. OIL FREE TURBO COMPRESSOR DESIGN FOR R744

A 100 kW R744 hermetic turbo compressor with two stages can be designed very compact. In principle the main design for the R744 turbo compressor is similar to the cut through drawing as shown in Figure 5, i.e. the electric drive of the unit is inside the shell.

The blade outer diameter is below 80 mm the total axial length is below 90 mm. Fluid bearings (foil-bearings) are applied, so no oil is required in the bearings, however, these bearing have to be cooled by a certain flow of CO₂.

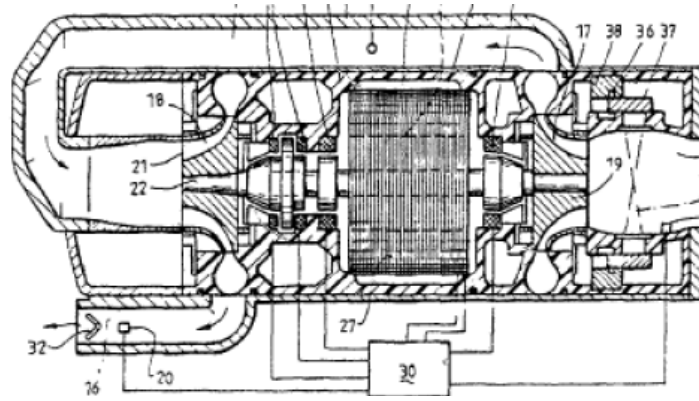

Figure 5 Principle cut through sketch of a hermetic turbo compressor (WO94/29597).

Figure 6 shows the preliminary design of the prototype, to be manufactured in 2011. The pilot system will be installed in the CREATIV lab at SINTEF/NTNU.

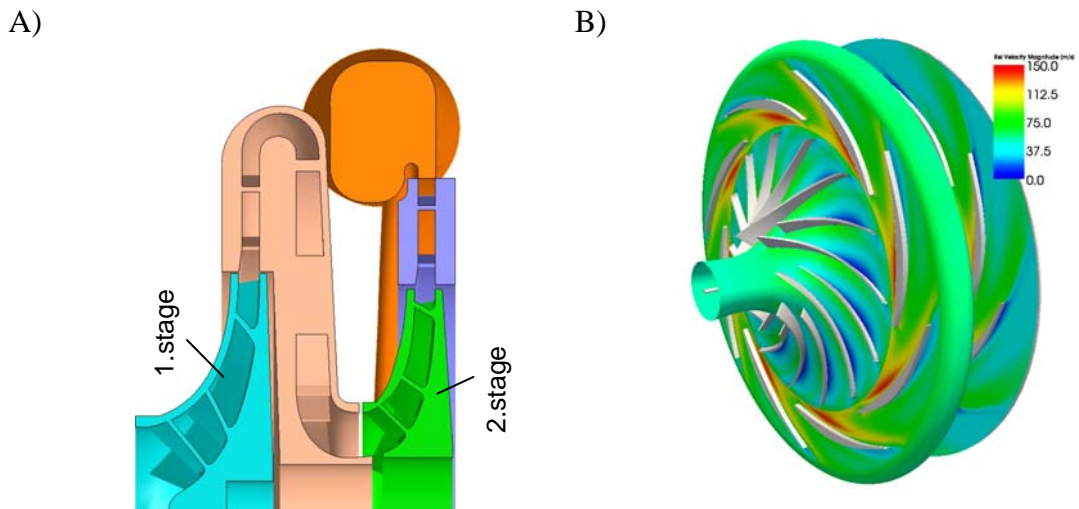

Figure 6 Cut through view of the R744 two stage compressor (A) & velocity analysis of the blades (B)

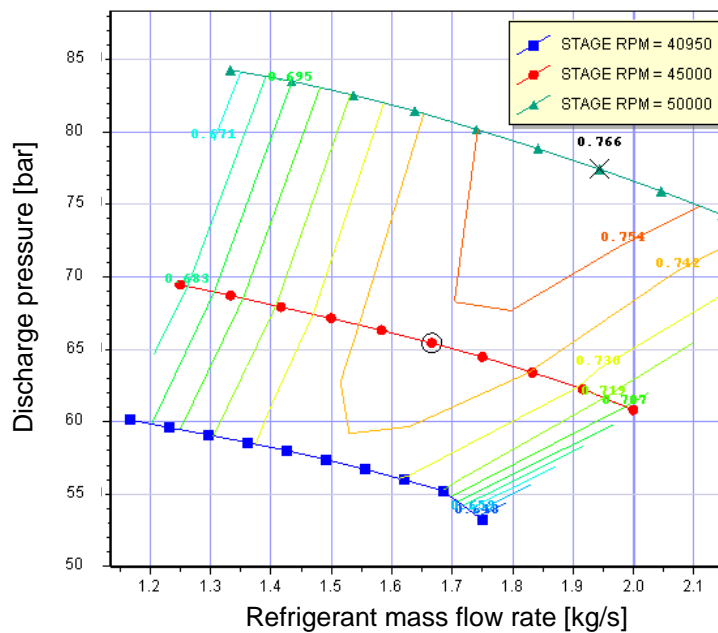

Figure 7: Efficiency map of R744 two stage compressor. Suction pressure: 30 bar.

The compressor is designed to operate at 30 bar suction pressure and a maximum pressure ratio of 3. The capacity of the compressor can be controlled within a certain range of the compressor RPM. As shown in Figure 7, the expected overall efficiency in the design point is in the range of 60% (wire to gas). Therefore it can serve as a baseline test plant for potential applications within commercial refrigeration, air conditioning, transport refrigeration, onboard Refrigerated Sea Water (RSW) production and industrial heat pumping systems.

5. SUMMARY

The introduction of oil free hermetic compressor technology for refrigeration and heat pumping systems would greatly improve the system performance and reduce the cost and complexity of the applications. In addition a cost reduction can be foreseen related to service and maintenance of the applications.

The favourable properties, i.e. comparable high heat transfer coefficients of carbon dioxide will not be depreciated by the lubricant, therefore high performance and compact heat exchangers can be realised in systems which apply this new type of hermetic turbo compressor for R744.

New temperature limits have to be defined, since the lubricant is not dictating the maximum discharge temperature of the compressor anymore. The compressor design has to be adapted for the area of operation, either ultra low temperatures or applications at elevated ambient temperatures.

A pilot system will be in operation in the laboratories of SINTEF/NTNU.

6. ACKNOWLEDGMENTS

This paper has been written as part of the work within the research project CREATIV, which is financially supported by the Research Council of Norway and several industry partners.

7. REFERENCES

- Dang, C., N. Haraguchi, and H.E. Yamada. *Effect of lubricant oil on boiling heat transfer of carbon dioxide*. in *7th IIR-Gustav Lorentzen Conference*. 2006. Trondheim, Norway.
- Dang, C., K. Lino, and K. Hihara, *Effect of PAG-type lubricating oil on heat transfer characteristics of supercritical carbon dioxide cooled inside a small internally grooved tube*. *International Journal of Refrigeration*, 2010. **33**: p. 558-565.
- FUCHS EUROPE SCHMIERSTOFFE GMBH. Personal communication with C. Puhl, 2.12.2010
- Hambraeus, K., 1995. *Heat transfer of oil-contaminated HFC134a in a horizontal evaporator*. *International Journal of Refrigeration*, 18(2):87-99.
- Gao, L., T. Honda, and S. Koyama, *Experiments on flow boiling heat transfer of almost pure CO₂ and CO₂-oil mixtures in horizontal smooth and microfin tubes*. *HVAC&R Res*, 2007. **13**(3): p. 415-425.
- Gao, L. and T. Honda. *Flow and heat transfer characteristics of refrigerant and PAG oil in the evaporator of a CO₂ heat pump system*. in *7th IIRGustav Lorentzen Conference*. 2006. Trondheim, Norway.
- Koyama, S., et al. *Experimental study on flow boiling of pure CO₂ and CO₂-oil mixtures inside horizontal smooth and microfin copper tubes*. in *6th IIR-Gustav Lorentzen Conference*. 2004. Glasgow, UK.
- Thome, J.R. 1995. Comprehensive thermodynamic approach to modeling refrigerant-lubricating oil mixtures. *HVAC&R Research*, 2:110-126.
- Yamaguchi, H., Zhang, X.R., Fujima, K., 2008. Basic study on new cryogenic refrigeration using CO₂ solid-gas two phase flow. *International Journal of Refrigeration* 31, 404-410.
- Youbi-Idrissi, M. and J. Bonjour, *The effect of oil in refrigeration: Current research issues and critical review of thermodynamic aspects*. *International Journal of Refrigeration*, 2008. **31**(2): p. 165-179.
- WO94/29597 Sketch of turbo compressor, as example.