

Corresponding author: Tel.: +47 735 937 48; fax: + 47 735 953 10.

Novel partial admission radial compressor for CO₂ applications

Bartosz Kus(a) and Petter Neksa(b)

(a) Norwegian University of Science and Technology

7491 Trondheim, Norway

Bartosz.Kus@ntnu.no

(b) Norwegian University of Science and Technology

7491 Trondheim, Norway

Petter.Neksa@sintef.no

ABSTRACT

A novel partial admission turbo compressor concept is proposed as an alternative to a conventional radial oil-free CO₂ compressor. The concept aims at the improvement of the overall performance through the reduction of the non-stage windage and cooling losses enabled by compression at significantly reduced shaft speeds. Transient CFD analysis gives fairly optimistic prediction of more than 80% of base stage efficiency at around 1.4 total pressure ratio. The study shows potential for

efficiency improvement by optimization of the shape and number of blades. The conceptual compressor may be an interesting alternative for commercial CO₂ applications operating at close to critical pressures, provided that the deceleration of the gas in the diffuser is efficient.

KEYWORDS

Novel partial admission compressor, Oil-free compressors, Oil-free refrigeration, CO₂ turbo-compressor

1. INTRODUCTION

According to Kus and Nekså (2013a and b) the performance of high pressure oil-free hermetic CO₂ turbo-compressors suffers from high windage and cooling losses triggered by operation under high shaft speeds and in a dense gas area. This concerns compressors particularly from lower capacity range (below 100 kW of shaft power) typically found in various commercial refrigeration applications. Refrigeration market consumes around 15 % (IIR, 2010) of global electricity production. Since employment of CO₂ as a working fluid often becomes an obvious choice for many of the refrigeration cycles, the matter of increased machinery efficiencies deserves more focus.

Although oil-free operation of refrigeration systems, including those using CO₂ is highly desirable, this issue is not widely addressed in the literature. Schiffmann and Favrat (2009, 2010) successfully tested small oil-free radial compressor for domestic heat pump utilizing R134a as a working fluid. Although good efficiency of the compressor is reported, significant difference in the density of the refrigerants does not promise achieving similar efficiencies in case of CO₂ compressor.

Previous studies on the subject of oil-free CO₂ compression [Kus and Neksa (2013b), Wright et. al. (2010)] suggest that pursuing high efficiencies is not an easy task and more research is needed. There seem to be two main approaches to reducing significant windage losses, namely introducing smaller motors with improved cooling or reducing rotational speeds. None of these approaches is straightforward. Development of new customized motors with better cooling strategies is expensive and involves extensive testing. Furthermore, additional cooling infrastructure will likely result in added cost and complexity to the compression systems. Significant reduction of shaft speeds is not the obvious solution either. In a typical radial compressor it will reduce specific speed of the impeller and therefore limit its aerodynamic efficiency.

Where small flow rates and low rotational speeds are design targets, partial admission machines could be considered. It is a commonly adopted practice to use partial admission machines in high pressure stages of small axial steam turbines. Such a configuration allows using relatively high blades and avoiding significant blade losses that would occur due to friction if the flow was admitted in the full arc. It is generally known that the efficiency of a partial admission stage is lower than that of a full admission one. This is caused by the rotor blades periodically passing through admitted arcs as well as the not admitted ones. Non-uniform velocity profile across the admitted arc can be also expected to result in impaired conditions of the diffusion process. Sakai et. al. (2006) validated 3D numerical analysis of a one-nozzle partial admission steam turbine with experimental data. The numerical grid for a one-stage turbine used in the CFD experiments of Sakai is presented in Fig 1.

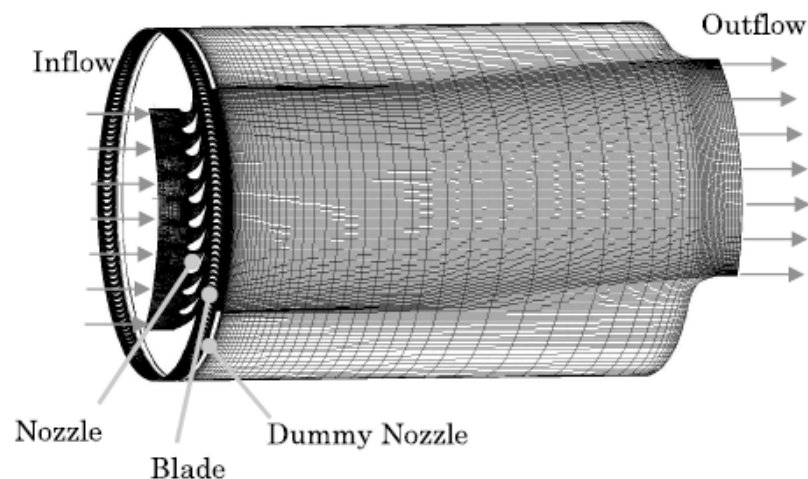

Figure 1. Numerical grid for simulation of partial admission axial steam turbine. Source: Sakai et. al.

(2006)

Another example of a partially admitted machine is the cross-flow blower, depicted in Fig 2. Usually it consists of forward curved blades with inner-to-outer diameter ratio of approximately 0.75 [Dang and Bushnell (2009)]. Various casing designs exist, but most of them are intended for approximately 90° flow turning from inlet to outlet. The cross-flow blower is two-stage machine where the flow is admitted on a certain part of the wheel arc and discharged through the opposite arc. Such a design creates characteristic fluid flow zones that limit the machine's efficiency.

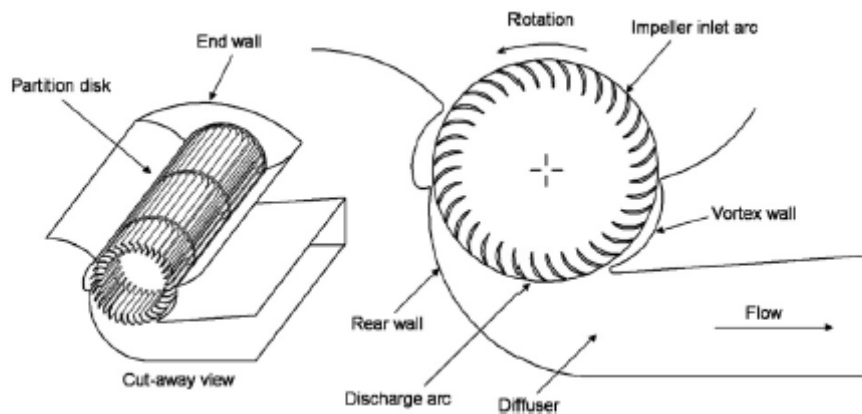

Figure 2. Typical cross-flow blower layout. Source: Dang and Bushnell (2009)

Three main zones can be distinguished, as indicated in Fig 3. In the zone designated with A, the main part of useful work is done. Due to the partial admission, zone B is formed, which behavior resembles that of a paddling wheel. The energy transfer in this region is regarded insignificant. Nevertheless, it contributes to the inefficiency of the compression process. Formation of an eccentric vortex in region C affects the shape of the through flow region, causing its contraction in the middle of the wheel. This contraction is an undesirable phenomenon as one would aim at proper diffusion process before the next compression stage. Additional reduction of the efficiency comes from energy dissipation in the vortex. Overall efficiency of the cross flow blower is known to be low, as well as achieved pressure ratios.

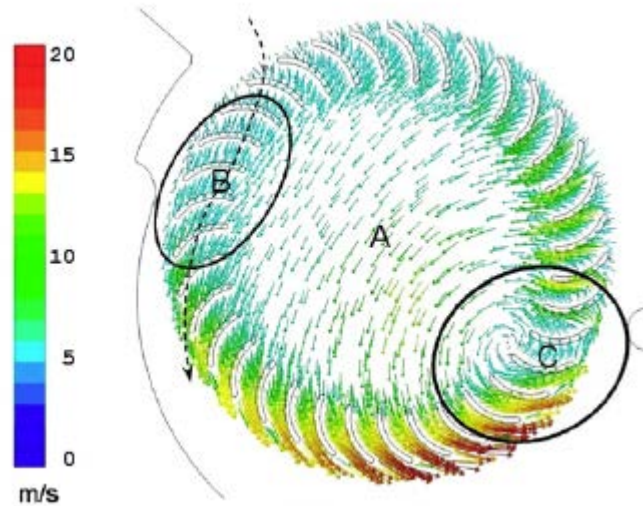

Figure 3. Three characteristic flow zones in cross flow blower. Source: Dang and Bushnell (2009)

The present paper attempts to utilize chosen features of both above concepts and merge them into a novel concept with proposed name of “partial admission radial compressor”. This study will try to answer whether the partial admission hermetic CO₂ compressor can be superior in terms of the overall efficiency compared to a state-of-the-art centrifugal concept. To be able to compare the novel compressor concept with a state-of-the-art machine the term “reference compressor” is introduced. For the sake of simplicity one-stage compressors will be compared.

2. THE REFERENCE COMPRESSOR CONCEPT

The reference one-stage high-speed hermetic radial compressor concept is depicted in Fig 4.

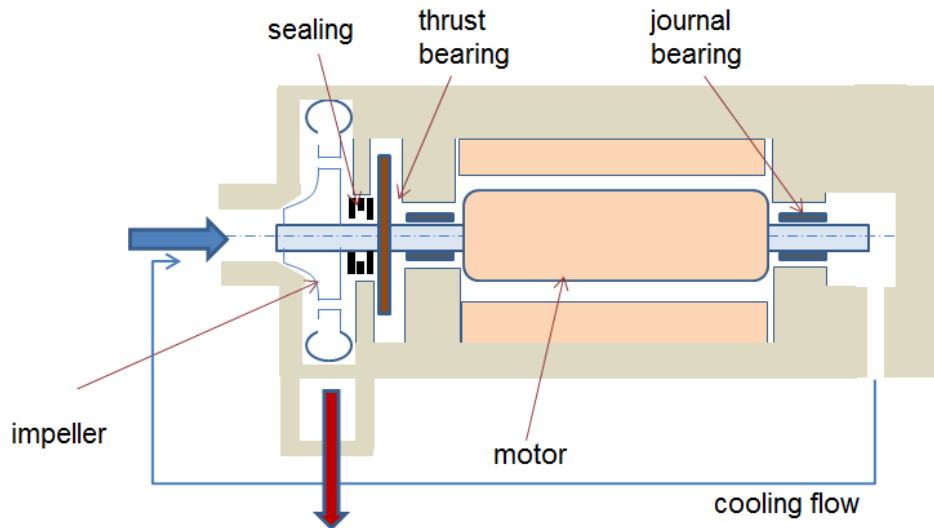

Figure 4. The reference compressor concept

For the preliminary design and performance estimation of the reference compressor the 1D tool presented in Kus and Neksa (2013a) will be used. The design assumptions are almost identical to those presented in Table 1 in Kus and Neksa (2013b), with the difference being the axial load. In the present comparison an optimistic value of 1000N is assumed for the axial thrust, which somewhat favors the standard compressor concept. Overall efficiency predictions presented in the present study do not include power loss in the electric driver.

An expected loss breakdown for a reference compressor designed for high operating pressure (80/113 bar), mass flow of 3.4 kg s⁻¹ and inlet temperature of 320 K is depicted in Fig 5. The machine is expected to operate at the shaft speed of 40 000 rpm, being a trade-off between good aerodynamic efficiency and low non-stage losses. The issue of optimal specific speed for hermetic CO₂ compressor is commented in Kus and Neksa (2013b).

It must be stated that while the expected stage efficiency is maintained at a rather high level, the overall efficiency of the machine is not satisfactory, especially when compared to state-of-the-art piston compressors used in CO₂ commercial refrigeration [Hafner et. al. (2012)].

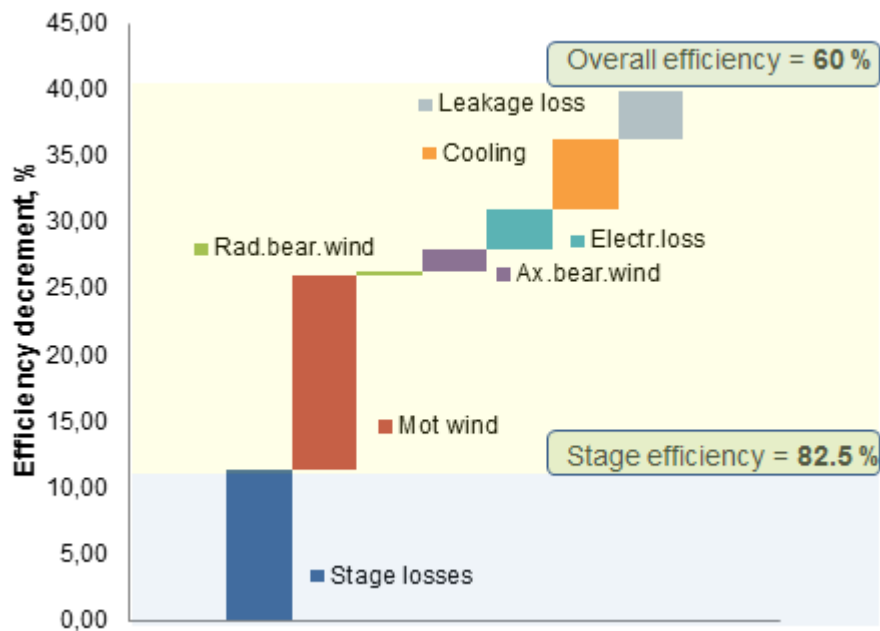

Figure 5. Predicted loss break-down for a state-of-the-art reference compressor designed for 80/113 operating pressure

If one was be able to maintain a reasonably high aerodynamic efficiency of the machine while significantly reducing operational speed then the overall performance of the compressor could be significantly improved. The partial admission radial compressor concept is introduced in an attempt to find out whether it could be possible.

3. THE “PARTIAL ADMISSION RADIAL COMPRESSOR” CONCEPT

In Fig 6 a summary of the challenges occurring with hermetic CO₂ oil-free compression are presented and two possible ways of tackling them are proposed. The two alternatives include a partial admission concept and application of a smaller, more slender motor. As mentioned, designing smaller motors

with higher gap shear stress and therefore increased cooling demand involves necessary experimental work. Another approach could be to employ special rotordynamic strategies for longer more slender motors. Applicability of such a strategy will also have limited impact [Kus and Neksa (2013b)]. Pursuing both approaches at once could give desirable effects. A detailed study of such an approach is however beyond limitations of the present work.

Instead, a strategy for development of a partial admission stage is pursued by performing a 2D CFD analysis, which could be made relatively rapid and inexpensive. The main question that the authors will try to answer in the present and the following papers is whether it is possible to maintain reasonable aerodynamic efficiency of a machine operating at significantly lower shaft speeds without significant increase in applicable flow rates.

Challenge \ Concept	Partial admission	Smaller motor/more slender motor
Axial bearing windage	No or near zero axial thrust – axial bearing dimensions significantly reduced	Balancing significant axial forces remains a challenge
Motor windage	Greatly reduced	Moderate reduction
Aerodynamic efficiency/pressure ratio	Inherently lower efficiencies and pressure ratios	High impeller efficiencies/pressure ratios
Bearing/seal technology	Lift-off seal more likely to be applied (non-hermetic work). Gas bearings still remain an option	Small and fast rotating shafts require hermetic operation and gas or magnetic bearings
Rapidity/Cost of initial development	Initial design and analysis possible with fairly rapid and inexpensive 2D CFD methods	Rotordynamic strategies possible to analyze with theoretical methods. Cooling strategies involve necessary testing

Figure 6. Comparison of a partial admission concept with a standard radial compressor

The concept of a partially admitted radial compressor is shown in the Fig 7. In the presented version of the concept the flow is admitted through a 33° arc. The impeller has an outer diameter of 16 cm and consists of 200 blades. The wheel rotates at 13000 revolutions per minute. The diffuser is not shown in the figure. The 3D design of the wheel is created by a simple extrusion of a 2D profile, hence initial modeling and optimization can be performed with help of 2D simulations. The flow is admitted in the radial direction. There is no turning of the flow from axial to radial direction as it happens in centrifugal compressors. Therefore, it is expected that axial loads generated by the wheel will be negligible, resulting in significantly reduced windage of the thrust bearing.

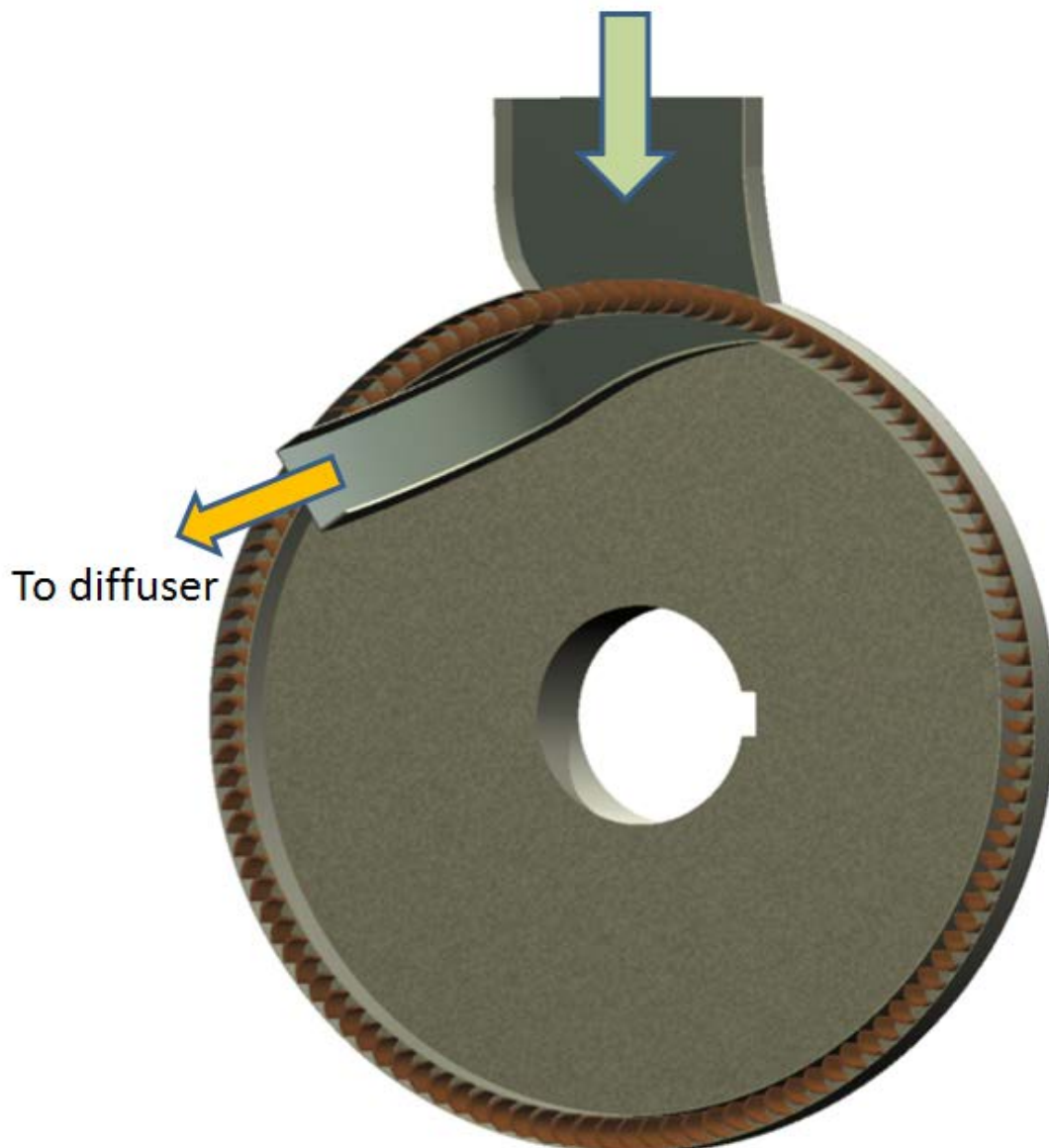

Figure 7. The concept of the partial admission CO₂ turbo-compressor

4. NUMERICAL MODELLING

For all CFD calculations the finite volume method code ANSYS FLUENT 14.0 was used. Averaged Navier Stokes equations were solved, and turbulence was modeled using the k- ϵ model. As the standard k- ϵ ceases to be valid in the vicinity of walls the wall boundary layers were calculated using wall functions. A second-order discretization scheme was used for all simulations. Peng-Robinson equations are used to simulate thermodynamic properties of CO₂.

The calculation domain consisted of three zones: stationary inlet zone, rotating impeller zone and stationary outlet zone. The diffuser is not simulated in the present work.

Boundary conditions

There is one flow inlet and one flow outlet. For the inlet, a mass flow boundary condition was used with total temperature and static pressure specified. A pressure outlet boundary condition with a prescribed static pressure and backflow total temperature was used for the stage outlet. The turbulence intensity at the boundaries is expected to be high in fast rotating turbo-machinery. A value of 10% was assumed for the simulations.

5. RESULTS and DISCUSSION

The whole analysis consisted of several steps. First, steady-state simulation of a 2-dimensional model fully bladed with 200 blades was conducted. Frozen rotor model was employed to preserve any circumferential non-uniformities occurring at the inlet and the outlet of the impeller wheel. The mesh developed in the first step was then used in a 2D transient simulation. Due to the time consuming nature of transient simulations only a single run was performed. To give the initial impression whether the performance of the compressor obtained from transient simulation could be maintained for other operating conditions, additional steady-state simulations were performed.

The mesh was developed for the boundary conditions summarized in Table 1. The same boundary conditions were used for the transient run.

Table 1. Simulation set-up used for mesh development

Parameter	Inlet mass flow, kg s⁻¹	Reference thickness of 2D profile, m	Outlet static pressure, bar	Inlet total temperature, K	Rotational speed, rpm
Value	180	1	40	330	13 000

The development of the mesh is presented in Table 2.

Table 2. Mesh independence study based on steady-state simulations

	Mesh size, mln cells,	$\mu_{is (t-t)}$	Average y^+	P_{ratio}
Mesh 1	0.68	0.824	250	1.42
Mesh 2	0.76	0.825	136	1.42

Mesh 3	0.90	0.829	80	1.42
Mesh 4	0.85	0.826	200	1.42
Mesh 5	0.95	0.826	114	1.42
Mesh 6	1.22	0.830	115	1.42
Mesh 7	1.4	0.833	66	1.42

Based on the above study mesh nr 6 was accepted as one providing sufficient resolution and was used for the further simulations. Snapshots of the geometry and final mesh are depicted in the Fig 8.

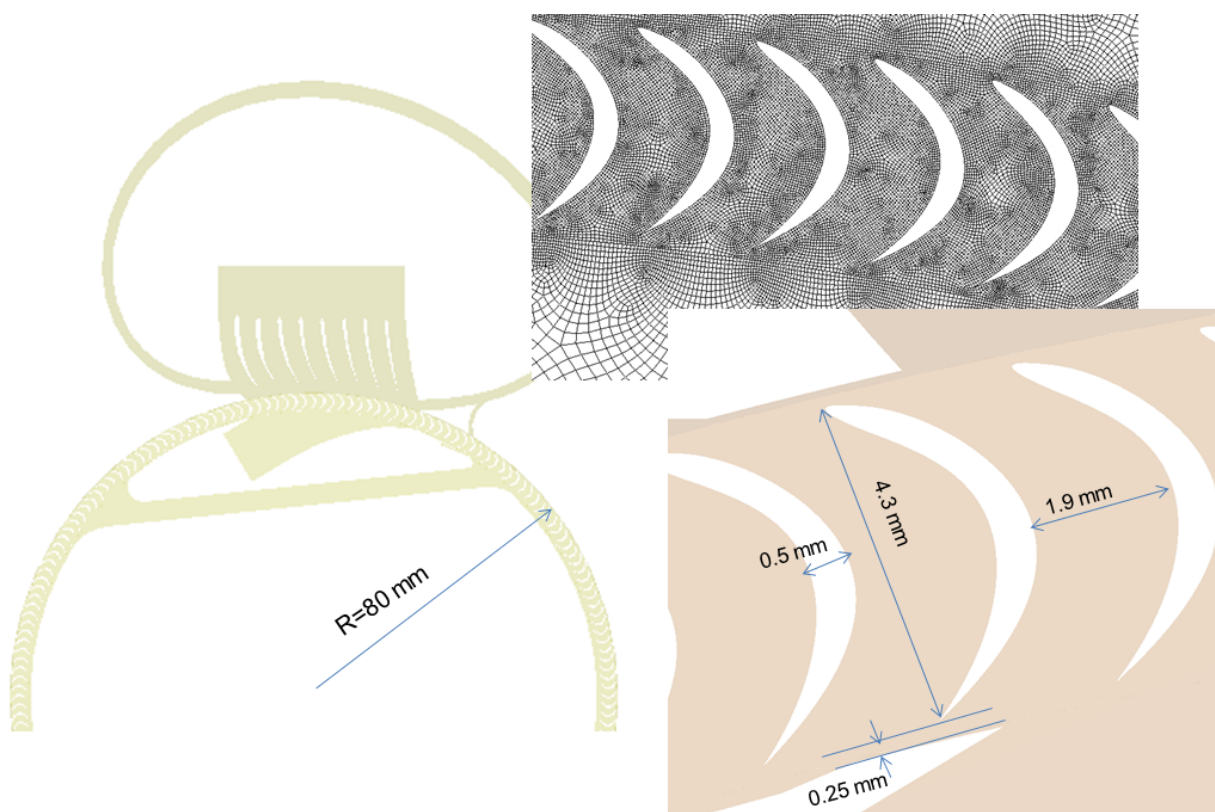

Figure 8. Two-dimensional mesh and geometry developed for steady-state and transient simulations

Steady state performance predictions

The developed mesh was used to perform several more steady-state simulations for slightly different rotational speeds and various operating pressures. The predicted peak efficiencies together with corresponding pressure ratios and absolute discharge Mach numbers are presented in Table 3.

Table 3. 2D Steady-state simulations. No diffuser included

Inlet conditions				Results		
P_{in} , bar	T_{in} , K	rpm	Mass flow, kg/s	P_{ratio} , -	$\eta_{is(t-t)}$, %	M_{02} , -
38.6	330	13000	210	1.44	83.3	0.73
38.6	330	15000	242	1.61	82.7	0.85
76.6	340	13000	458	1.50	83.9	0.67
73.7	340	14000	458	1.58	83.5	0.69

Based on the results presented in Table 3 one can expect that for optimized flow rates the proposed concept can achieve similar performance for different operating conditions and that pressure ratios higher than 1.4 could be achieved with reasonable efficiencies.

Transient operation performance prediction

Due to the inherently transient nature of the processes present in a partially admitted machine, dynamic simulation with a sliding mesh was run. The simulation run for 19 000 time steps representing twelve full revolutions of the wheel. The time step of $3e-6$ s resulted in the 10 time steps passing period for one blade. The history of important solution monitors is presented in Fig 9.

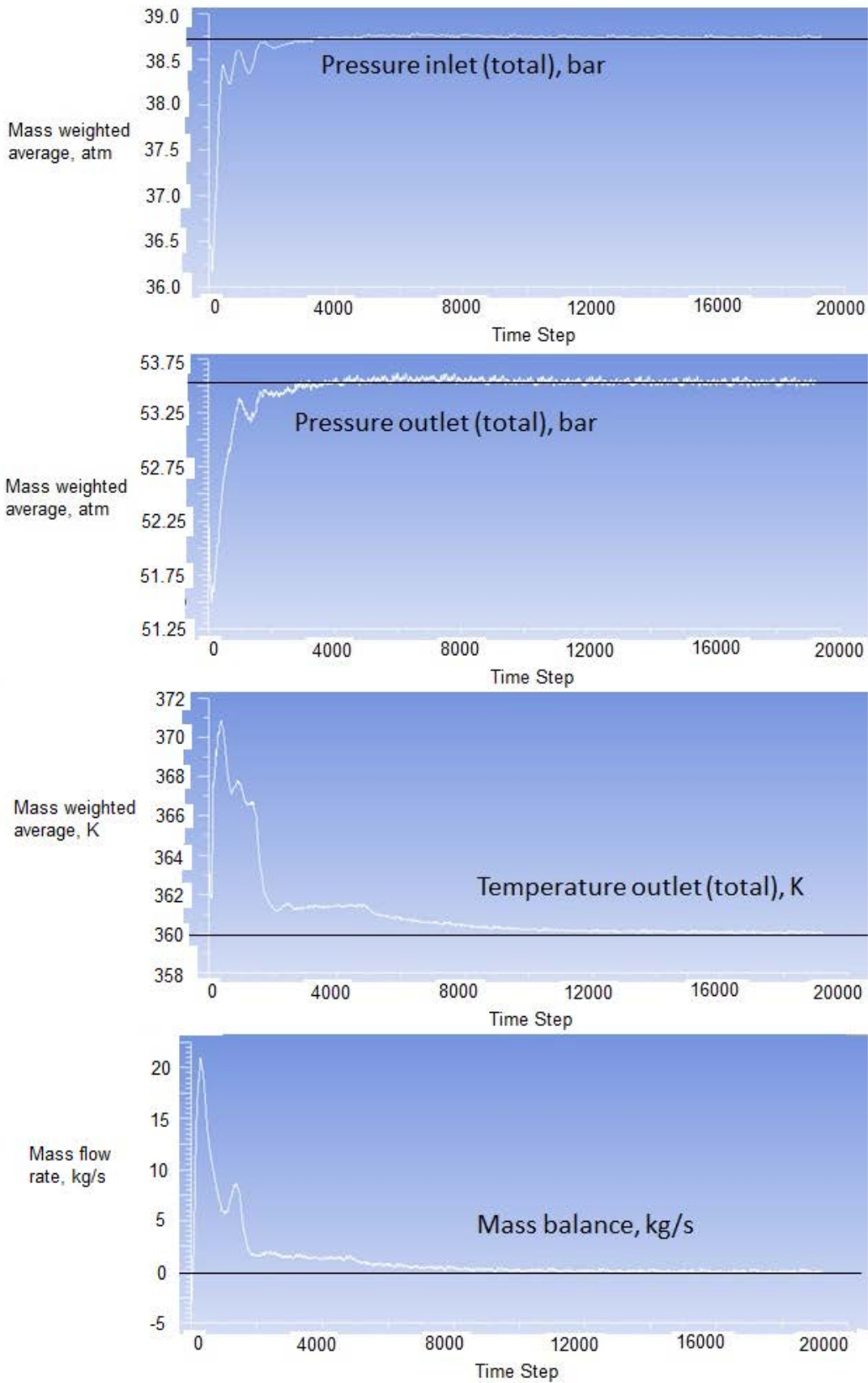

Figure 9. Main monitors' history of the transient simulation

The comparison of the velocity field obtained by steady state and transient simulations are presented in Fig10.

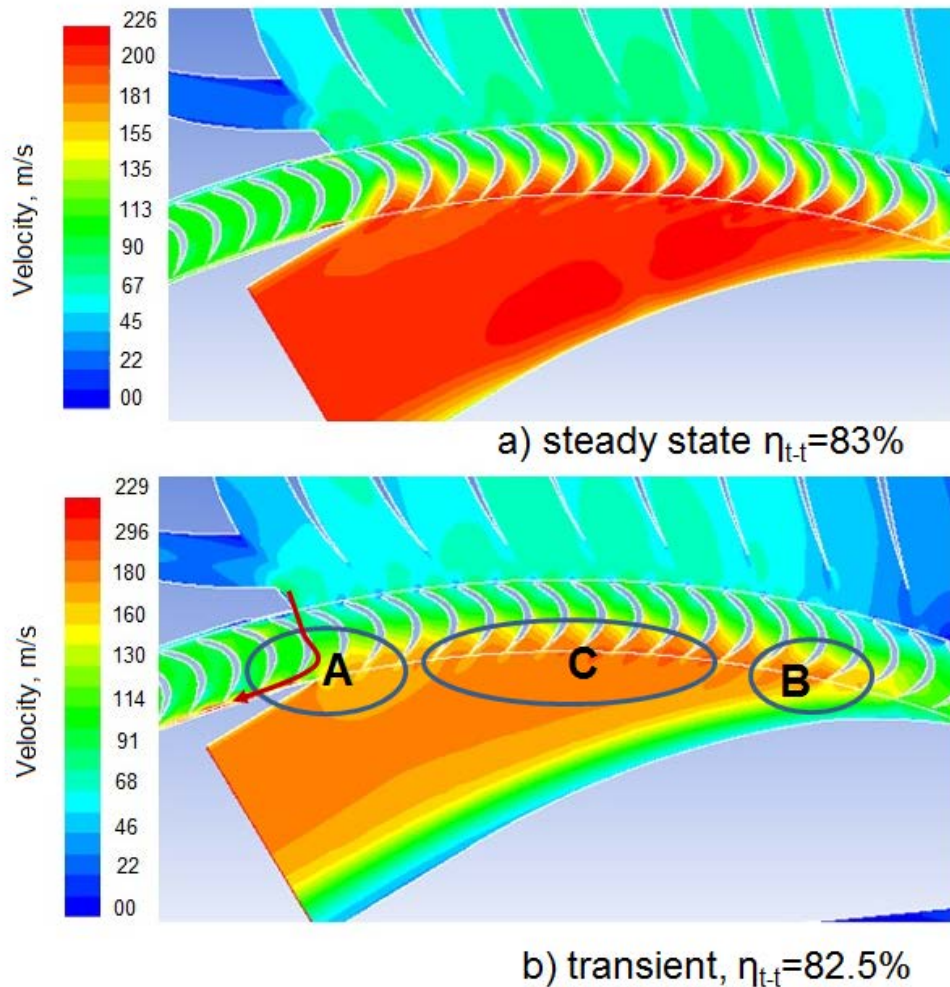

Figure 10. Comparison of velocity field obtained by steady-state and transient CFD analysis

It can be observed that steady state simulation has limited ability to capture two important phenomena depicted in Fig 10 within Zone A and Zone B. Zone A covers a region where the discharge of the fluid passing the blades is restricted by the collector wall. This restriction results in reduced fluid velocity compared to the main through flow (Zone C) and therefore reduced velocity at the inlet of the blades. The result is increased incidence losses but also dissipation of part of the energy transferred to the fluid into the cavity (marked with an arrow). In this region a combination of clearance and sudden expansion loss occurs. The increased incidence loss is also present in the Zone B where the impeller

blades only starts transferring usable work to the incoming fluid. The mixing of the active and inactive gas results in the mixing losses. The impact of a sudden expansion and mixing losses can theoretically be limited by increasing admission ratio of the compressor or by applying shorter blades. The optimal size of the blade will likely depend on a necessary curvature that must be achieved across the blade relatively smoothly and mechanical and manufacturability limitations.

Increased admission rate must also be analyzed carefully for each case. Firstly, because the particles leaving each particular blade, due to the inward flow configuration, have conflicting flow paths. Hence, for a given impeller diameter increased admission will result in worse flow uniformity in the collector channel. In such a case, application of discharge vanes does not guarantee improved performance due to the additional friction and incidence losses resulting from high velocity discharge conditions. Secondly, for a given design flow rate increased admission arc must be followed by a lower extrusion of the 2D profile (blade height) and therefore higher impact of wall friction effects.

In the presently analyzed case, due to the already very short blades and reasonably high admission ratio the impact of transient effects resulted in a total efficiency reduction from 83 to 82.5% for steady state and transient run respectively. Accordingly, the total pressure ratio dropped from 1.42 to 1.38.

The more pronounced difference between steady state and dynamic simulation is visible in the prediction of the discharge velocity profile. Non uniform velocity profile presented in Fig 10b is very undesirable phenomenon with regard to the efficient deceleration of the gas during the diffusion process. Furthermore, the diffuser channel must include a bent section required to direct the gas outside of the wheel. It is therefore anticipated that the proper design of the diffuser will be of critical importance to the high overall stage efficiency of the presented concept.

The initial prediction of the overall efficiency of the machine based on the partial admission concept is undertaken in the following section. In order to compare overall efficiency of a novel compressor a full spectrum of losses such as diffuser, disc friction and non-stage losses must be included in the analysis.

Overall efficiency prediction

Overall performance of a hermetic partial admission compressor is predicted and compared against the reference compressor for two different sets of operating conditions and varying flow rates. For estimation of both concepts' overall performance the tool presented in Kus and Neksa (2013a) is used. The 1D tool developed for radial compressor concept must be provided with a stage performance of the novel compressor in order to predict its overall efficiency. To specify stage performance the pressure loss in the diffuser must be assumed. Our initial CFD estimations suggest that this loss could be in order of 0.7-2 bar for the high speed flow of around 200 m/s. For the sake of simplicity this pressure drop will be assumed in the present study. In Fig 11 it is shown how the total pressure loss in the diffuser affects overall stage efficiency of the partial admission concept when the base efficiency value of 82.5% is assumed. This efficiency is expected to drop to 76% for 1 bar pressure loss in diffuser. For 2 bar diffuser pressure loss the stage efficiency is expected to amount only to 71%. Proper design of the diffuser is therefore crucial in achieving reasonable efficiency of the partial admission machine.

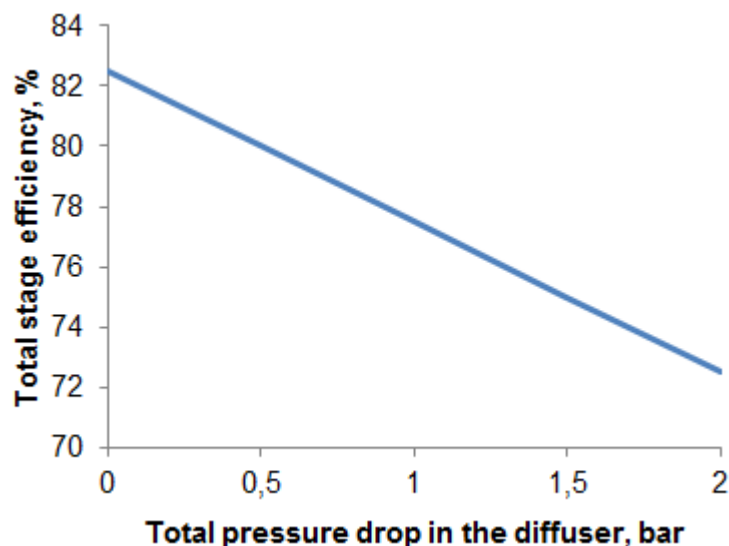

Figure 11. Stage efficiency vs diffuser total pressure drop

To commence a 1D overall performance prediction of the new concept a new value of 75% total stage efficiency is now assumed. This efficiency is further expected to drop for compressors designed for reduced flow rates. 3D CFD steady state simulations were performed for different geometries created by simple extrusion of 2D profile to roughly assess impact of the wall friction on the compressor efficiency. To reduce the computational effort a periodic boundary was applied and only 1/6 of the wheel was simulated.

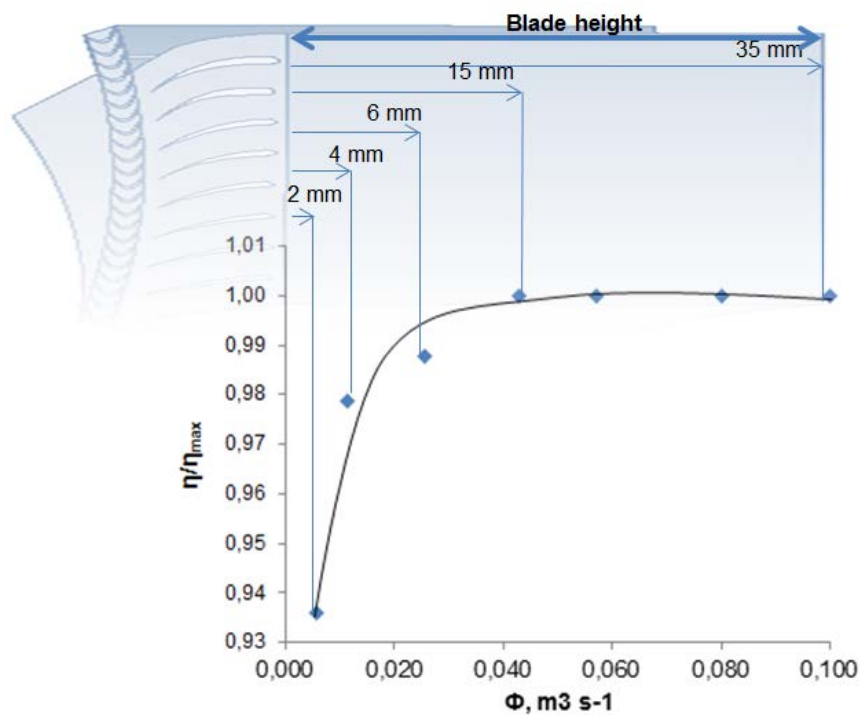

Figure 12. Predicted impact of wall effects on the performance of a partial admission compressor depending on a blade height

From Fig 12 it can be seen that for a given 2D design the basic stage efficiency starts to drop significantly for the design flow rates lower than 0.02 m³ s⁻¹. Such a flow rate corresponds to around 30 kW of the stage compression power for the compression conditions used in the transient simulation run. The impact of wall effects must be incorporated into the 1D model in order to evaluate performance of the partial admission compressor for various flow rates. Also the disc friction which is not accounted for in the CFD prediction is taken into account. The remaining losses common for both concepts are included as well:

- Electrical loss in the motor
- Cooling loss
- Motor windage
- Bearing windage

The calculation of the above losses incorporates default settings of the 1D tool presented in Kus and Neksa (2013a and b). The assumed axial loads amount to 100N and 1000N for a novel and reference compressor respectively. 1D predictions of overall efficiencies for both compressor concepts are presented for different operating conditions in Fig 13 and 14.

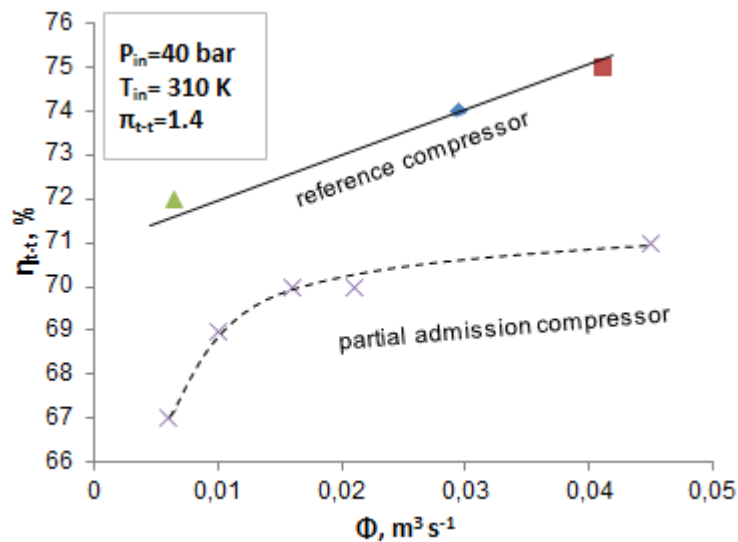

Figure 13. Prediction of overall peak efficiencies for two compressor concepts designed for different flow rates.

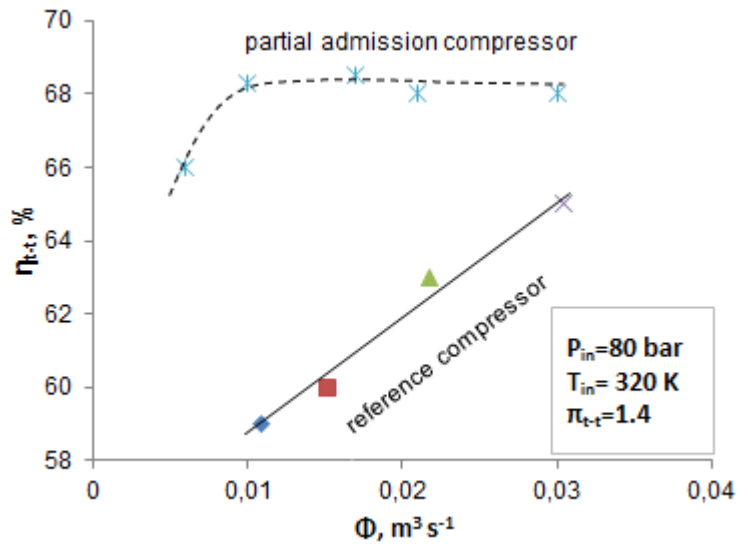

Figure 14. Prediction of overall peak efficiencies for two compressor concepts designed for different flow rates.

The overall performance predictions allow presuming that the partial admission concept can be an interesting option especially for the applications where operating pressure is high and flow rates moderate, i.e. supercritical CO₂ commercial applications. In such cases lower stage efficiency of the partial admission concept can be accepted due to the significantly reduced non-stage losses, such as windage and internal cooling. In cases where operating pressures are low to moderate, high aerodynamic performance of a traditional radial compressor and moderate non-stage losses will favor a conventional radial compressor concept over a partially admitted machine.

Impact of a blade shape

The presented transient simulation was run for a particular number and shape of the blades. A further study has shown that efficiency of the blade and therefore efficiency of the machine could be improved. Due to the time consuming nature of transient simulations for a complete geometry, a few additional blade configurations were examined with respect to their maximum performance at the rotational speed of 13 000 rpm. Steady-state simulations of the fully admitted wheel were performed. A frozen rotor approach with periodic boundary of 7.2 degree was utilized in order to reduce





computational effort. An example of a meshed domain depicting the reference blades (used in transient simulation run) is presented in Fig 14.



Figure 14. The meshed domain of 1/50 of the full wheel depicting the reference blade shape

In Table 4 the impact of the shape and number of blades on the maximum wheel efficiency is presented. The direction of the flow, inlet and discharge angles and the radial span of analyzed blades remain the same as in the base geometry used for transient simulation. It is shown that increasing number of the reference blades from 200 to 250 will improve the wheel efficiency by around 1%. Application of droplet-like blade (Blade B) will reduce the wheel efficiency but also the flow rate for which the wheel achieves optimal performance. The reduced peak efficiency can be attributed to the increased blockage at the leading edge of the blade and less smooth through flow compared to the reference blade. The best peak performance among analyzed blades was achieved for the Blade C. It achieves 2.3% higher efficiency than the reference blade, both in 200 blades configuration. It can likely be attributed to the lowest curvature of the through flow for this blade and sharp leading edge resulting in low blockage. Furthermore, Blade C due to its thickness is expected to achieve higher stiffness that could prove to be critical in a further mechanical design process.

Table 4. Impact of the shape and number of blades on the attainable wheel efficiency

		Grid size	Y+	η_{t-t}	P_{ratio}	Φ/Φ_{ref}
Blade A, 200 bl	Grid1	50000	322	89.2	1.45	1
<i>Reference blade</i>	Grid2	60000	160	89.1	1.45	1
	Grid3	156000	370	89.0	1.45	1
	Grid4	166000	160	89.0	1.45	1
Blade A, 150 bl	Grid1	50000	310	84.6	1.41	1
	Grid2	60000	155	84.7	1.41	1
	Grid3	166000	160	84.7	1.41	1
	Grid4	184000	80	84.6	1.41	1
Blade A, 250 bl	Grid1	50000	270	90.2	1.41	0.78
	Grid2	60000	134	90.3	1.41	0.78
	Grid3	152000	280	90.0	1.41	0.78
	Grid4	163000	140	90.0	1.41	0.78
Blade B, 200 bl	Grid1	48000	268	82.8	1.36	0.75
	Grid2	58000	136	83.0	1.36	0.75
	Grid3	156000	274	82.7	1.36	0.75
	Grid4	166000	138	82.6	1.36	0.75

Blade C, 200 bl	Grid1	49000	337	91.3	1.47	1
	Grid2	62000	170	91.2	1.47	1
	Grid3	150000	345	91.3	1.47	1
	Grid4	160000	172	91.3	1.47	1

CONCLUSIONS

A novel partial admission concept of an oil-free turbo-compressor for CO₂ applications is presented as an alternative to high speed centrifugal machines. The main advantage over state-of-the-art centrifugal compressor is significant reduction of the non-stage losses typically triggered by the elements of the compressor rotating at high speeds in a dense gas. Greatly reduced shaft speeds enable the designer to consider more typical variants of bearings, namely oil or grease lubricated bearings in conjunction with shaft sealed with dry gas seals.

It is generally known that partial admission machines are aerodynamically less efficient than their fully admitted counterparts. However results of CFD simulations of the proposed concept are reasonably optimistic when it comes to the stage efficiency. The transient 2D simulation performed for the base geometry showed around 82.5% isentropic efficiency for a stage achieving 1.38 total pressure ratio. This efficiency is predicted for the main part of the compressor including an inlet vanes row, the impeller wheel and the outlet collector. Depending on the 3D depth the profile (blade height), a drop in the base efficiency caused by the wall effects can be expected. It is predicted that a more pronounced drop in efficiency occurs for blade heights of less than 5 mm. It accounts for volumetric flow rates of less than 0.02 m³ s⁻¹ corresponding to cooling capacity of around 500 kW at 60bar. Applicability of the proposed concept may also be limited for significantly higher flow rates where stiffness of the long blades can become an issue. Further reduction of the base efficiency will also occur in the diffuser. The diffuser design will be covered in later work.

Achieved efficiencies cannot be regarded as what optimally can be achievable for the partial admission concept, but hopefully they give a first reasonable approximation. Presented geometry cannot be regarded as the optimal one either. It is shown that optimization of the blade shape and number of blades should improve the base efficiency of the concept.

It is viewed that achieved CFD results and estimates of total efficiency are reasonably optimistic and will be used as a starting point for the design of the diffuser. The diffuser will have deciding impact on the final stage efficiency, and therefore more attention will be devoted to its design in a separate publication. It should also be noted that presented work does not take into account radial leakage that will be present in the partial admission compressor. This leakage however is believed to be of minor significance in terms of overall performance as the fluid leaking through the radial gap will not undergo any energy transfer in the blades. To gain more confidence in the presented CFD study an experimental work will be necessary.

ACKNOWLEDGMENTS

This publication forms a part of the CREATIV project, performed under the strategic Norwegian research program RENERGI. The authors acknowledge the partners: SINTEF Energy Research, Danfoss, FHL, Hydro Aluminium, John Bean Technology, Norske Skog, REMA1000, Systemair, TINE, and the Research Council of Norway (195182/S60) for their support. The authors would like to thank Barber-Nichols Inc. for the valuable comments to the present work.

NOMENCLATURE

μ_{is} (-)	Isentropic efficiency
Y^+ (-)	Dimensionless wall distance
M (-)	Mach number
P_{ratio} (-)	Pressure ratio
Φ (m ³ s ⁻¹)	Volumetric flow rate

Subscripts

02	Absolute discharge conditions
t-t	Total/total

REFERENCES

1. Dang, T. Q., Bushnell, P.R., 2009. Aerodynamics of cross flow fans and their application to aircraft propulsion and flow control. *Progress in Aerospace Sciences* 45, 1–29
2. Hafner, A., Nekså, P., Rekstad, H., 2012. High efficient 100kW shaft power R744 compressor. 10th IIR Gustav Lorentzen conference on natural refrigerants (June 2012) in Delft, the Netherlands
3. IIR, 2010. Statement given by Didier Coulomb, Director of the International Institute of Refrigeration. United Nations Climate Change Conference, Cancun, Mexico, November 29 – December 10, 2010
4. Kus, B. and Nekså, P., 2013a. Development of one-dimensional model for initial design and evaluation of oil-free CO₂ turbo-compressor. Submitted to *Int J Refrig*
5. Kus, B. and Nekså, P., 2013b. Oil-free turbo-compressors for CO₂ refrigeration applications. *Int J Refrig*, 2013

6. Sakai, N., Harada, T., Imai, Y., 2006. Numerical study of partial admission stages in steam turbine. JSME International Journal. Series B, Vol.49, No.2
7. Schiffmann, J., Favrat, D., 2009. Experimental investigation of a direct driven radial compressor for domestic heat pumps. Int. J. Refrig. 32, 1918 – 1928
8. Schiffmann, J., Favrat, D., 2010. Design, experimental investigation and multi-objective optimization of a small-scale radial compressor for heat pump applications. Energy. 35/8, 436-450
9. Wright, S.A., Radel, R.F., Vernon, M.E., Rochau, G.E., Pickard, P.S., 2010. Operation and Analysis of a Supercritical CO₂ Brayton Cycle, Sandia Report SAND2010-0171