

Investigation of dry ice blockage in an ultra-low temperature cascade refrigeration system using CO₂ as a working fluid

Hiroshi Yamaguchi^a, Xiao-Dong Niu^{a,*}, Kenichi Sekimoto^a, Petter Nekså^b

^aEnergy Conversion research Center, Doshisha University, Kyoto, Japan

^bSINTEF Energy Research, NO-7465 Trondheim, Norway

Abstract

Dry ice blockage in a CO₂-solid-gas-flow-based ultra-low temperature cascade refrigeration system is investigated experimentally. Visualization test shows that dry ice sedimentation occurs at low mass flow rates. The sedimentation also occurs at low condensation temperature and low heating power input. Based on the present investigation, it is found that the present ultra-low temperature cascade refrigeration system is better to work at heating power input above 900W and condensation temperature above -20°C. At suitable operating condition, the present ultra-low temperature cascade refrigeration system has been shown the capability of achieving ultra-low temperature -62°C continuously and stably.

Keywords: Dry ice; Solid-gas flow; Ultra-low temperature cascade refrigeration system.

1. Introduction

CO₂ is abundant in nature and comes at low cost. As an environmentally benign fluid it has properties of zero Ozone depletion potential (ODE), low global warm potential (GWP), non-toxicity, non-flammability and inertness (ASHRAE Handbook). In addition, the thermodynamic and transport properties of CO₂ is also favorable for its using as a refrigerant in terms of its good

* Author to whom correspondence should be addressed. Email address: xniu@mail.doshisha.ac.jp

heat transfer and large pressure drop at the critical pressure and temperature of CO₂ are 7.38MPa (73.8bar) and 31.1°C respectively (Liao & Zhao, 2002). Because of the above advantages, CO₂ fluid has received much attention in recent years in developing various energy conversion systems (Lorentzen 1990, 1993, 1994; Neksa et al. 1998, 2002; Hafner 1998; Liao et al. 2002; Saikawa 2004; Girolto et al. 2004; Cechinato et al. 2005; Rieberer 2005; Stene 2005; Zhang et al. 2005; Kim et al. 2004, 2009).

In 2008, a cascade refrigeration system using CO₂ solid-gas two-phase flow is introduced by Yamaguchi et al. and it has been shown to be able to achieve the ultra-low temperature below the CO₂ triple-point temperature of -56°C. The system is comprised of two CO₂ refrigeration compression cycles (Fig. 1), and the temperature below the triple-point is realized by an expansion process of the liquid CO₂ into the dry ice and gas mixtures in an expansion tube. The reason designing a cascade system is due to a low condensing temperature necessary for dry ice condensation in expanding process. As shown in Fig. 1, this system is composed of a low temperature cycle (LTC) and a high temperature cycle (HTC), respectively. In HPC, CO₂ is cooled to -20°C through a compressor, two condensers, a needle expansion valve and an evaporator. In LTC, one more condenser is used and cooled by the brine from the evaporator of HPC. Through three condensers in HPC, CO₂ is cooled to below -20°C and then expanded into the expansion tube to achieve the dry ice-gas two-phase flow and obtain an ultra-low refrigeration temperature below the triple point. Brine cycle connects the evaporator of HTC and the gas cooler of LTC. The refrigeration principle of that system is illustrated in Fig. 2. The process of 1-2 represents the liquid CO₂ expansion into the two-phase flow in the dry ice region, which is below the CO₂ triple point. The ultra-low temperature refrigeration in the system is achieved by the CO₂ dry ice sublimating and absorbing heat from outside of the expansion tube. This process is shown in 2-3 in Fig. 2.

The feasibility study of the ultra-low temperature CO₂ cascade refrigeration system has been performed by Yamaguchi and Zhang (2009). As the dry ice may sediment in the expansion tube and blocks the CO₂ flow and makes the system operation failed, it is very necessary to investigate the dry ice behaviors in the expansion tube for getting the optimized system operation condition. For this aim, in the present work, the behavior of liquid CO₂ expanding into a horizontal tube through the expansion valve is first studied by the visualization test in a special open loop. Then, the dry ice sedimentation effects on the cascade system are investigated at different conditions.

The rest of the paper is organized as follows. In Sec. II, details of the visualization and dry-ice sedimentation tests in the cascade system are introduced. Sec. III is devoted to results and discussions of the present study. A conclusion is given in Sec. IV.

2. Experiment details

2.1 Visualization test

In order to investigate the dry ice sedimentation in the expansion tube in the CO₂ cascade refrigeration system, a special experimental set-up is built and is sketched in Fig. 3. The experimental set-up is mainly comprised of a CO₂ container, a pressure control valve, an expansion valve, a test section with visualization and heating parts and an orifice flow meter. In order to get useful information for the CO₂ cascade refrigeration system (Fig. 1), The test section is made with similar dimensions of the expansion tube in LTC of the cascade refrigeration system. The visualization part in the test section is a Pyrex circular tube. The heating part in the test section is a SUS316 circular tube rounded by sheath heater for sublimating the CO₂ dry ice particle in it. Although the loop is open one, both the visualization and heating sections are set long enough so that the solid-gas flows with/without CO₂ sublimation can be observed. The

visualization and heating tube has dimensions of length 1.93m (Visualization 0.59m and heating 1.34m), thickness 0.0025m and inner diameter 0.04m. In order to keep enough low temperature in the test section, a double cylinder with vacuum thermal insulation structure is installed in the test section to avoid heat transfer between the piping and the ambient.

In the experiment, gas-liquid CO₂ in the container is pressurized into the gas-liquid separator through the pressure control valve. In the separator, only liquid fluid is introduced to the expansion valve and the CO₂ gas is recycled to the container. The expansion valve is a needle-type expansion valve with a maximum diameter of 30 mm. Through the expansion valve, the liquid CO₂ expands, and the dry ice particles are produced by Joule-Thomson effect. In the heating section, the dry ice-gas flow is heated under the constant heat flux condition by the sheath heater so that the dry ice sublimation occurs in the heating tube. After the heating section, the gas CO₂ flows through the orifice flow meter and then is discharged outside. Visualization observation is achieved by using the high-speed video camera. All the visualization tests are performed at pressure of 1.0MPa and temperature of -45°C at the inlet of the tube.

2.2 *Dry ice sedimentation test in CO₂ cascade refrigeration system*

The performance of the CO₂ cascade refrigeration system based on the visualization results is also carried out. Here we neglect the details of the CO₂ cascade refrigeration system, which can be referred to the work of Yamaguchi and Zhang (2009). The performance study is based on the temperatures and pressures measured at different positions in the system (see Fig. 1). T-type thermocouples with an uncertainty of 0.1°C and pressure transmitter with an uncertainty of 0.2% are used for the measurements. All measured data are transferred into computer through distributor and data logger. The sample data are obtained in every 5s. In the pressure measurement, each two pressures of the CO₂ fluid are obtained at the inlet (suction) and outlet

(discharge) of the compressors in HTC and LTC in the system, and for LTC they are denoted as P1 and P2 and for HTC denoted as P1' and P2'. In the temperature measurement, each four temperatures of the CO₂ fluid are obtained respectively for HTC and LTC. In HTC, they are suction temperature T1' at the compressor inlet, discharging temperature T2' at the compressor outlet, condensing temperature T3' at the outlet of the cooling water condenser, and T4' at the evaporator outlet. In LTC, they are suction temperature T1 at the compressor inlet, discharging temperature T2 at the compressor outlet, condensing temperature T3 and sublimation temperature T4 before and after the expansion valve, respectively.

The details of the test section of the expansion tube in LTC with temperature and pressure measuring positions is sketched in Fig. 4. The test section is a copper-made horizontal circular tube, which has an internal diameter of 0.04m and outer diameter of 0.045m. The length of the test section is 5.0 m. The inlet pipe and outlet pipe have a thickness of 0.0015m and an outer diameter of 0.01588m and 0.02222m, respectively. The heater used to heat the tube is silicon gum type heater with good water proof. The heater can be used in a low-temperature environment until -80°C.

In the experiment, HTC is started first and cools the brine of second subsystem. After the brine is fully cooled, the heater rounded in the expansion tube in LTC is started to preheat the tube. When the expansion tube in LTC reaches the prescribed temperature, LTC is started. Then the two machine systems should be made to operate simultaneously. The stable state of the system operation is judged by observing whether T1 and T4 in LTC are converged into a confined range. In the present work, pressure and temperature become steady around 3 hrs later from starting working HTC and LTC. After that, average pressure and temperature during 26-minute period are adopted.

3. Results & Discussions

3.1 Visualization test

The visualization test is carried out at the two opening conditions of 10mm and 15mm of expansion valve (corresponding low and high mass flow rate, respectively). Figs. 5 (a) and (b) show the pictures of the solid-gas two phase fluids at two respective opening conditions of the expansion valve taken by a high-speed camera with 13500fps. In Fig. 5. black and white regions represent the dry ice particles and CO₂ gas, respectively. It is seen that the solid-gas fluid flows are successfully achieved by liquid CO₂ expanding process through the needle valve. The particle distribution is almost uniform at the expansion valve condition of 15mm (Fig. 5 (a)). At this high flow rate, the flow is considered to be turbulent and thus helping the uniform distribution of the dry ice formation in the expansion tube. From the visualization results, the diameters of most dry ice particles are estimated about 1.0mm. By taking average of 100 sample particles, the mean particle size is measured to be 1.023mm. When the opening condition of the expansion valve is reduced to 10mm, as shown in Fig. 5 (b), it is observed that a sedimentation phenomena occurs and larger particles forms in the expansion tube. The sedimentation and large particles appeared in low mass flow rate is mainly due to the flow speed is small, and the movement of particles is more difficult to overcome the viscous drag forces inside the fluid and on the tube wall than at high mass flow rate. As a consequence, the particles inside the tube at low mass flow rate collide and stick with each other to form large particles more easily.

3.2 Dry ice sedimentation test in CO₂ cascade refrigeration system

The behavior of dry ice blockage phenomenon in the test section of the cascade system can be detected by examining the suction and discharge pressures before and after the compressor, condensing pressure before the expansion valve and pressures in the test section in LTC varying

with the time. In the following, results based on two typical conditions, at which dry ice sedimentation and blockage occur in the expansion tube in LTC of the cascade system, are presented.

The suction and discharge pressure behaviors before and after the compressor in LTC at the expansion valve opening in 10mm, the condensing temperature of -20°C and the heating power input 900W are described in Fig. 6. As shown in Fig. 6, the discharge pressure has a sudden rise while the suction pressure slightly decreases during the time of 120 ~ 180 mins. The suddenly change of the discharge and suction pressures is caused by the dry ice accumulating in a large amount in the inlet channel connected to the expansion tube (Fig. 4) and blocking the liquid CO_2 flowing. This finding can be confirmed in Fig. 7, which shows the behavior of measured condensing pressure and those at four position along the test section (see Fig. 4) in the time period of 120 ~ 200 mins for the expansion valve opening in 10mm, the condensing temperature of -20°C and the heating power input 900W. As shown in Fig. 7, the condensing pressure rises remarkably in the time range of 150 ~ 170 mins, and the local pressures P_1 , P_2 , P_3 and P_4 at four positions of the test section vary slightly within the operation time, indicating clearly that the blockage of dry ice occurs in the inlet of the expansion tube.

Fig. 8 displays the suction and discharge pressure behaviors before and after the compressor in LTC at the expansion valve opening in 15mm, the condensing temperature of -25°C and the heating power input 1200W. In this figure, both of the suction and discharge pressures are observed to slightly decrease in the time period of 120 ~ 150 mins, suggesting that the dry-ice particles partly sediment on the wall of the expansion tube and change the CO_2 solid-gas two-phase flow behaviors inside it. This can also be confirmed by measuring condensing pressure and those at four positions along the test section. Fig. 9 shows the behavior of measured condensing pressure and those at four position along the test section (see Fig. 4) in the time period of 120 ~

150 mins for the expansion valve opening in 15mm, the condensing temperature of -25°C and the heating power input 1200W. As shown in Fig. 9, the local pressures P_1 , P_2 , P_3 and P_4 rise drastically and the condensing pressure varies little within the plotted operation time, illustrating that the sedimentation of dry ice occurs on the wall of the expansion tube.

The detailed dry ice sedimentation inside the test section can be illuminated in Fig. 10 with displaying the variations of local pressures and temperatures at four typical blocking times at the expansion valve opening in 15mm, the condensing temperature of -25°C and the heating power input 1200W. The measured positions of pressures and temperatures are also given in the illuminated figures. The sedimentation of dry ice first appears in the inlet region of the test section, and then gradually moves to downstream with the time going. Before the dry ice sediment point, the pressure and temperature rise due to the flow entrapped. The large temperature variation near the outlet of the test section observed in the figure is mainly due to the flow rapidly shrinking to the tube connected to the compressor.

Figs. 11 (a) and (b) plot the variations of the measured steady-state suction pressure P_1 in LTC with the heating power input at three condensing temperatures T_3 of -15°C , -20°C and -25°C for two opening conditions of 10 mm and 15 mm of the expansion valve, respectively. It is found in both Figs. 11 (a) and (b) that, except at low heating power input of 900W, the suction pressure generally decreases with the condensing temperature and the heating power input decreasing. At the heating power input of 900W, the suction pressure at condensing temperature of $T_3 = -25^{\circ}\text{C}$ increases for the expansion valve opening in 15mm (Fig. 11 (a)), implying the sedimentation of dry ice may occurs to partly block the flow. For the expansion valve opening in 10mm as shown in Fig. 11 (b), due to the serious blockage phenomenon occurring in the inlet of the expansion tube at the heating power input of 900W, the evaporating pressure can not be measured.

3.3 Performance of the CO₂ cascade refrigeration system at an optimized operating condition

Based on the above investigations, it is found that the present ultra-low temperature cascade refrigeration system is better to work at heating power input above 900W and condensation temperature above -20°C. Fig. 12 shows the measured suction and discharge pressures in HTC and LTC varying with time at the heating power input of 1000W and the opening of the expansion valve of 15mm, and Fig. 13 plots the measured suction, discharge and condensing temperatures in HTC and LTC varying with time at the same conditions. As shown in Figs. 12 and 13, the measured pressures and temperatures quickly reach in a certain value range after started, and it takes about 180 mins for the suction and discharge temperatures to become stable. In HTC, the discharge pressure is $P_2' = 6.60\text{MPa}$, the discharge temperature is $T_2' = 136^\circ\text{C}$, the condensing temperature is $T_3' = 25.1^\circ\text{C}$, the suction pressure is $P_1' = 1.65\text{MPa}$ and the suction temperature is $T_1' = -15^\circ\text{C}$. The oscillation of the discharge pressures and temperatures shown in Figs. 12 and 13 are mainly due to the automatic valve opening and closing in cooling tower side, which the temperature variations of cooling water in the heat exchangers. By comparing the $p-h$ diagram shown in Fig. 2, it is confirmed that, in HPC, the CO₂ fluid state is of gas state at the compressor inlet and outlet, of supercritical state at the outlet of the condensers, and of liquid-gas two-phase state at the inlet of the evaporator. In LTC, the discharge pressure is $P_2 = 2.20\text{MPa}$, the discharge temperature is $T_2 = 136^\circ\text{C}$, the condensing temperature is $T_3 = -17^\circ\text{C}$, the evaporator outlet temperature is -62°C , and the suction pressure and temperature of the compressor are $P_1 = 0.36\text{MPa}$ and $T_1 = -30^\circ\text{C}$, respectively. Based on $P-h$ diagram in Fig. 2 again, the CO₂ fluid state is confirmed to be of gas state at the compressor inlet and outlet, of liquid state at the inlet of the expansion valve and of solid-gas two-phase state at the inlet of the test section. Based on Figs. 12 and 13, it is certain that the CO₂ cascade refrigeration system could

continuously and stably realize the dry ice-solid two phase flow and an ultra-low temperature of -62°C in the expansion tube.

4. Conclusions

Dry-ice blockage in a CO_2 -solid-gas-flow-based ultra-low temperature cascade refrigeration system is investigated experimentally. Visualization test shows that dry ice sedimentation occurs in low mass flow rate. The investigation with the cascade system to simulate the dry-ice-gas two-phase flow through the expansion valve shows that the dry-ice flow blockage in the expansion tube has the following characteristics:

Dry-ice blockage occurs in the inlet of the expansion tube at low mass flow rates, low condensation temperature and low heating power input. When the mass flow rate increases, blockage occurs in the expansion tubes due to the dry-ice particles partly accumulating on the wall of the expansion tube.

Based on the present investigation, it is found that the present ultra-low temperature cascade refrigeration system is better to work at heating power input above 900W and condensation temperature above -20°C . At suitable operating condition, the present ultra-low temperature cascade refrigeration system has been shown the capability of achieving ultra-low temperature -62°C continuously and stably.

References

- ASHRAE Handbook-Fundamentals (I-P edition, American Society of Heating, Refrigerating and Air-Conditioning Engineers, Inc., 2009)
- Cecchinato, L., Corradi, M., Fornasieri, E., Zamboni, L., 2005. Carbon dioxide as refrigerant for tap water heat pumps: a comparison with the traditional solution. International Journal of

- Refrigeration 28, 1250–1258.
- Giroto, S., Minetto, S., Neksa, P., 2004. Commercial refrigeration system using CO₂ as the refrigerant. *International Journal of Refrigeration* 27, 717–723.
- Hafner, A., Pettersen, J., Skaugen, G., Neksa, P., 1998. An automobile HVAC system with CO₂ as the refrigerant. In: IIR-Third IIR-Gustav Lorentzen Conference on Natural Working Fluids, June 2–5, 1998, Oslo, Norway.
- Kim, M.H., Pettersen, J., Bullard, C.W., 2004. Fundamental process and system design issues in CO₂ vapor compression systems. *Progress in Energy and Combustion Science* 30, 119–174.
- Kim, S.C., Won, J.P., Park, Y.S., Lim, T.W., Kim, M.S., 2009. Performance evaluation of a stack cooling system using CO₂ air conditioner in fuel cell vehicles. *International Journal of Refrigeration* 32, 70–77.
- Liao, S. M., and Zhao, T. S., 2002. An experimental investigation of convection heat transfer to supercritical carbon dioxide in miniature tubes. *Int. J. Heat Mass Transfer*, 45, 5025-5034.
- Lorentzen, G., 1990. Trans-critical Vapour Compression Cycle Device, International Patent Publication WO 90/07683.
- Lorentzen, G., 1993. Large heat pumps using CO₂ as refrigerant. In: IIR Energy Efficiency in Refrigeration and Global Warming Impact, May 12–14, 1993, Gent, Belgium.
- Lorentzen, G., 1994. Revival of carbon dioxide as a refrigerant. *International Journal of Refrigeration* 17, 292–301.
- Neksa, P., Giroto, S., Schiefloe, P.A., 1998. Commercial refrigeration using CO₂ as refrigerant-system design and experimental results. In: IIR-Third IIR-Gustav Lorentzen Conference on Natural Working Fluids, June 2–5, 1998, Oslo, Norway.
- Neksa, P., 2002. CO₂ heat pump systems. *International Journal of Refrigeration* 25, 421–427.
- Rieberer, R., 2005. Naturally circulating probes and collectors for ground-coupled heat pumps.

- International Journal of Refrigeration 28, 1308–1315.
- Saikawa, M., 2004. Development of Home CO₂ Heat Pump Hot Water Supplying Apparatus, Science of Machine 56, 446-451.
- Stene, J., 2005. Residential CO₂ heat pump system for combined space heating and hot water heating. International Journal of Refrigeration 28, 1259–1265.
- Yamaguchi, H., Zhang, X.R., Fujima, K., 2008. Basic study on new cryogenic refrigeration using CO₂ solid–gas two phase flow. International Journal of Refrigeration 31, 404–410.
- Yamaguchi, H., Zhang, X.R., 2009. A novel CO₂ refrigeration system achieved by CO₂ solid–gas two-phase fluid and its basic study on system performance. International Journal of Refrigeration 32, 1683–1693.
- Zhang, X.R., Yamaguchi, H., Fujima, K., Enomoto, M., Sawada, N., 2005. A feasibility study of CO₂-based Rankine cycle powered by solar energy. JSME International Journal – Series B: Fluids and Thermal Engineering 48, 540–547.

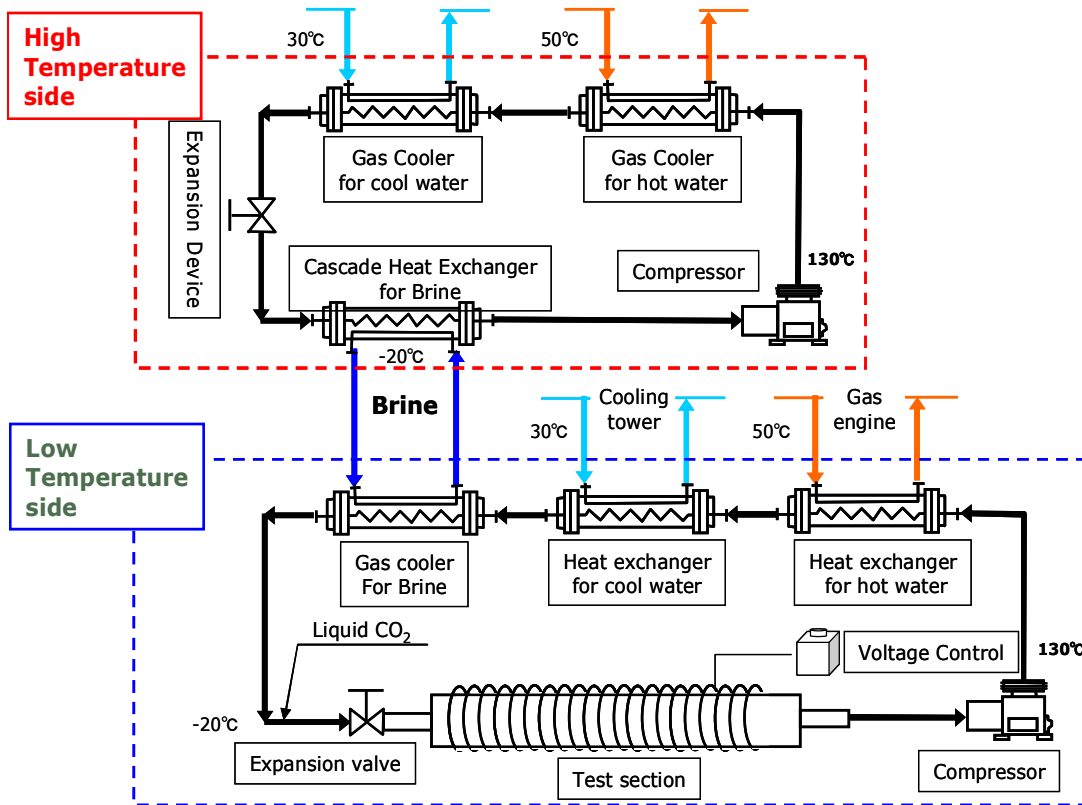

Fig 1. Schematic of the CO₂ cascade refrigeration system

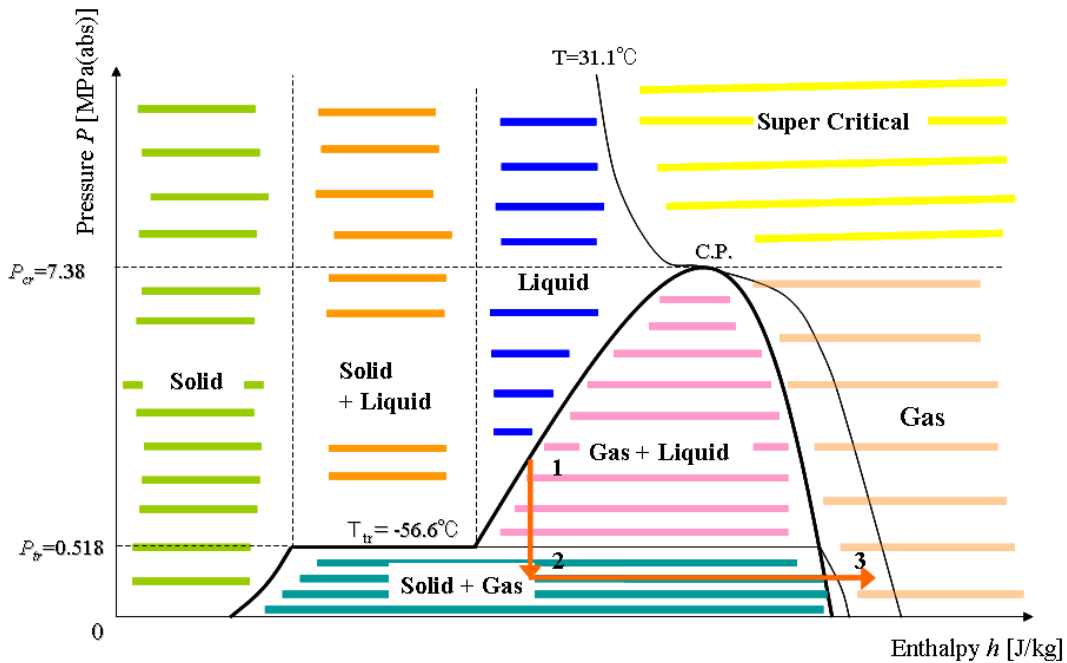
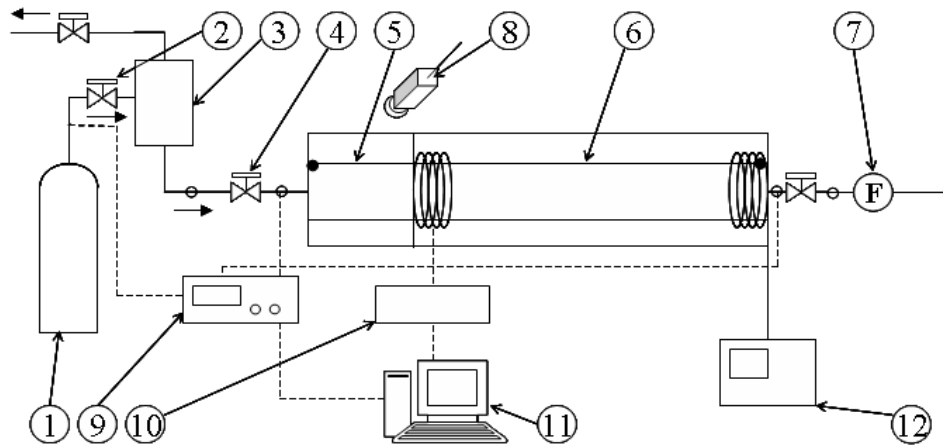

Fig 2. P-h diagram for carbon dioxide.



- | | |
|-----------------------------|-------------------------------|
| ① CO ₂ container | ⑦ Orifice flow meter |
| ② Pressure control valve | ⑧ Hi-speed camera |
| ③ Gas-liquid separator | ⑨ Amplifier |
| ④ Expansion valve | ⑩ Temperature data controller |
| ⑤ Visualization section | ⑪ Computer |
| ⑥ Heating section | ⑫ Sheath Heater |

- Pressure measurement point
- Temperature measurement point

Fig 3. Schematic of experiment set up

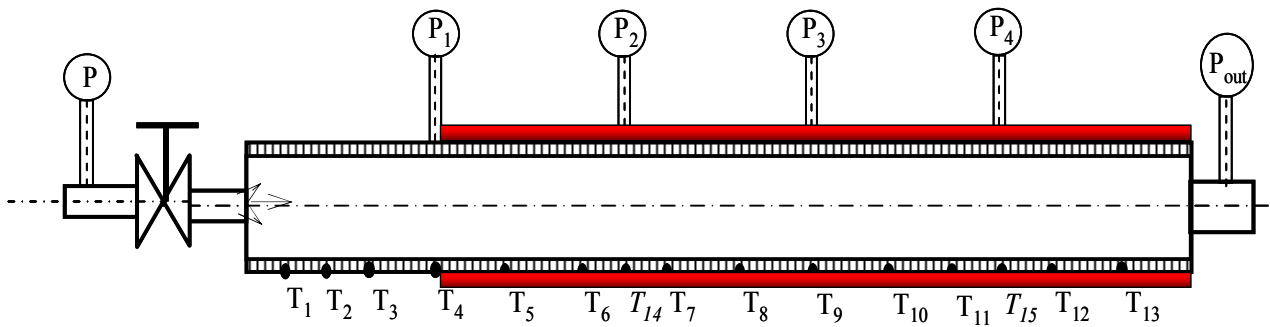
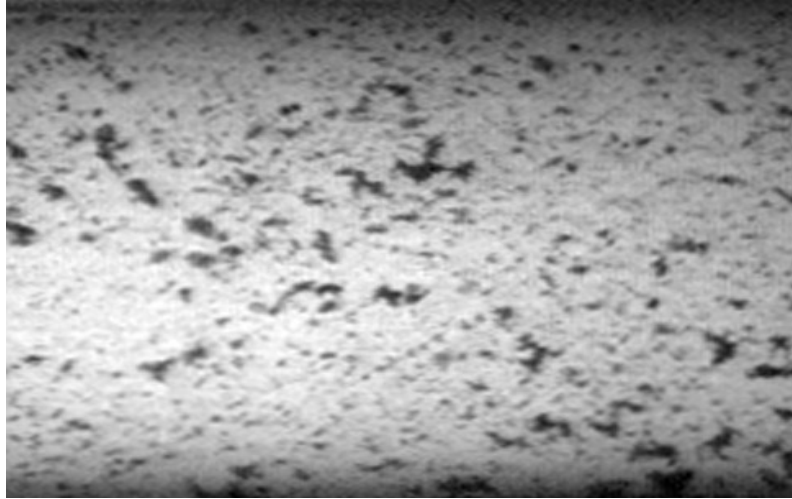
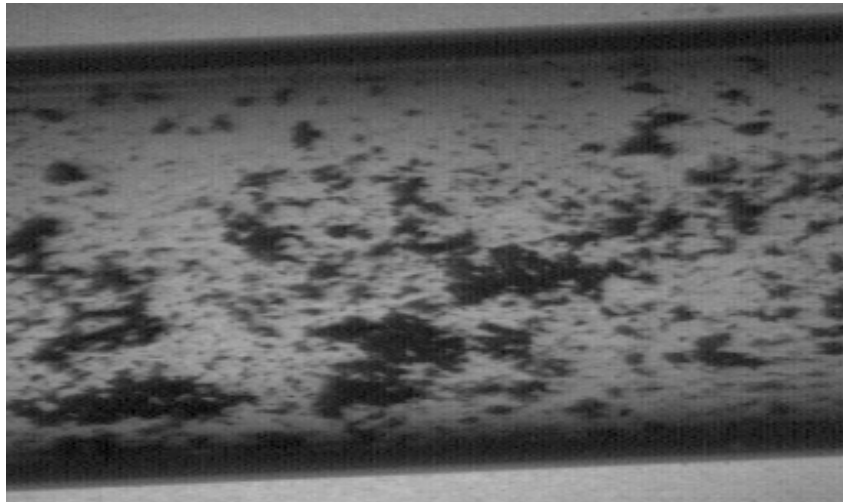

Fig 4. Schematic of test section of expansion tube in LTC



(a) CO₂ solid-gas flow at opening conditions of 15mm of expansion valve



(b) CO₂ solid-gas flow at at opening conditions of 10mm of expansion valve

Fig 5. Pictures of CO₂ solid-gas two phase flows achieved from liquid CO₂ expansion throughout CO₂ triple point. (**black region** represents dry ice particles and **white region** represents CO₂ gas phase; pictures are taken at 13500fps by high-speed camera)

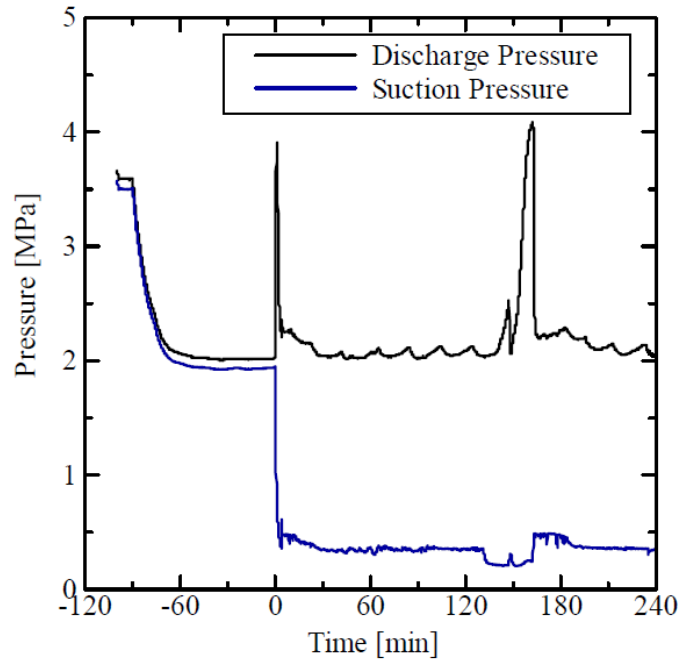

Fig 6. Measured suction and discharge pressures in LTC vary with time (the expansion valve opening in 10mm, the condensing temperature of -20°C and the heating power input 900W).

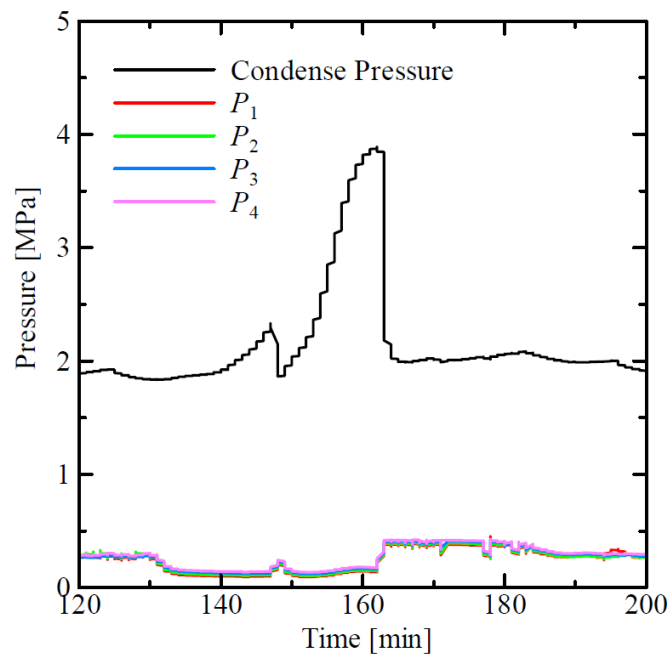

Fig 7. Behavior of measured condensing and local pressures in test section at expansion valve opening 10mm, condensing temperature -20°C and heat input 900W

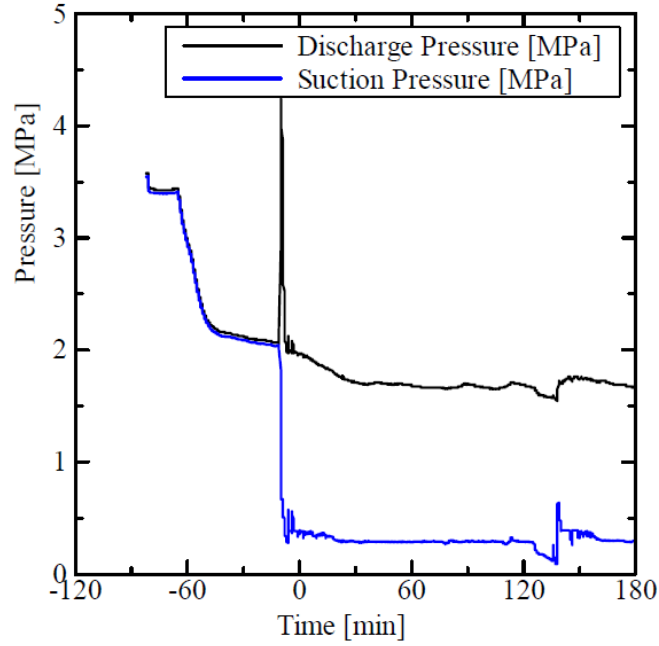

Fig 8. Measured suction and discharge pressures in LTC vary with time (the expansion valve opening in 15mm, the condensing temperature of -25°C and the heating power input 1200W).

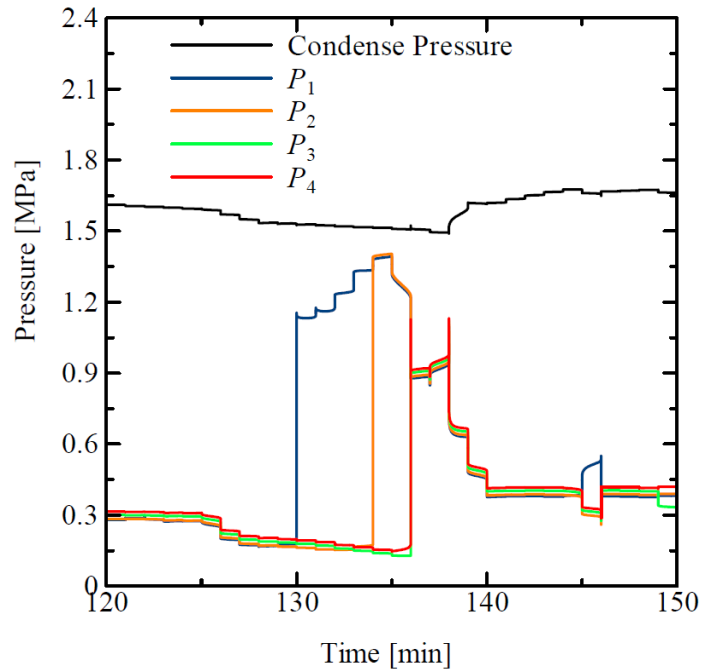

Fig 9. Behavior of measured condensing and local pressures in test section at expansion valve opening 15mm, condensing temperature -25°C and heat input 1200W

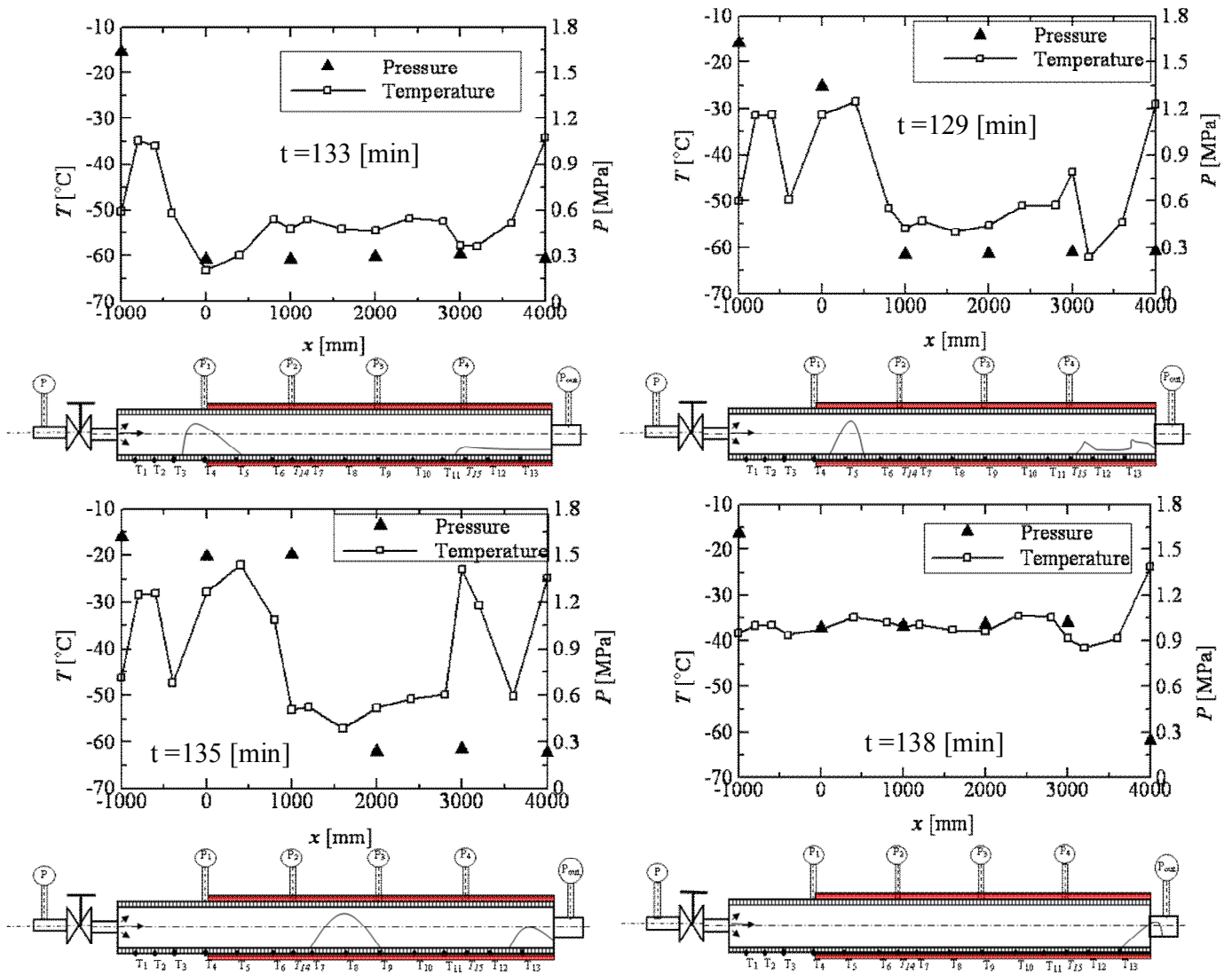
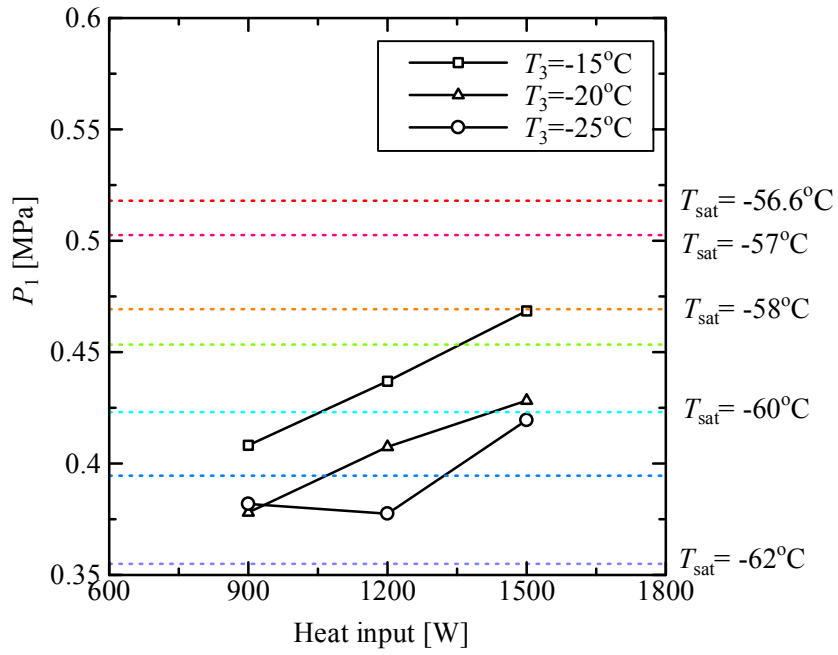
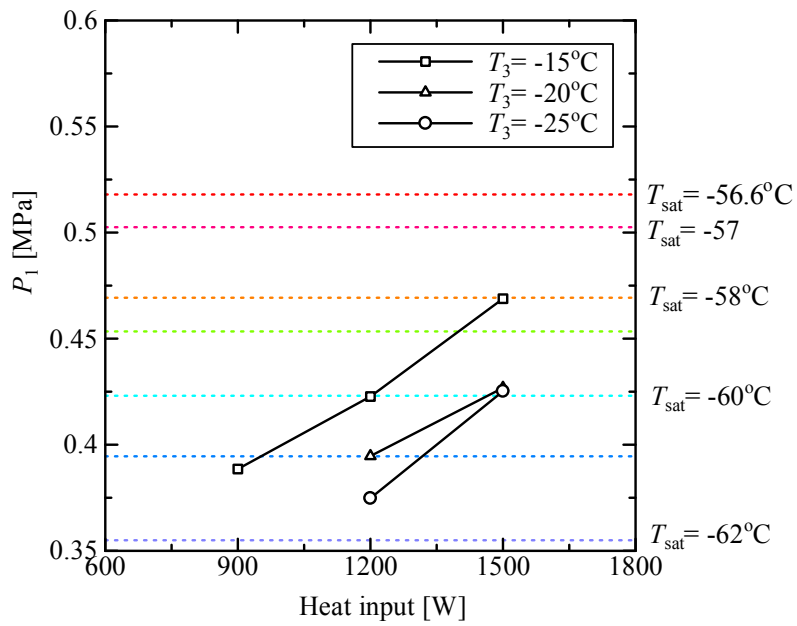

Fig. 10 Variations of local pressure and wall temperature with the dry ice sedimentation inside the test section at different times.



(a) Expansion valve opening in 15mm



(b) Expansion valve opening in 10mm

Fig 11. Variations of measured evaporating pressure of LTC with heat input at three condensation temperatures and two expansion valve opening.

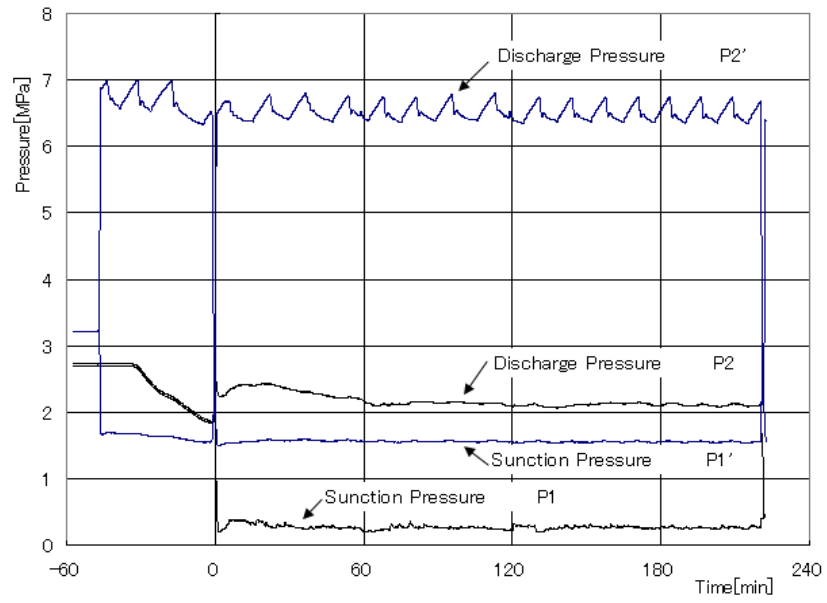
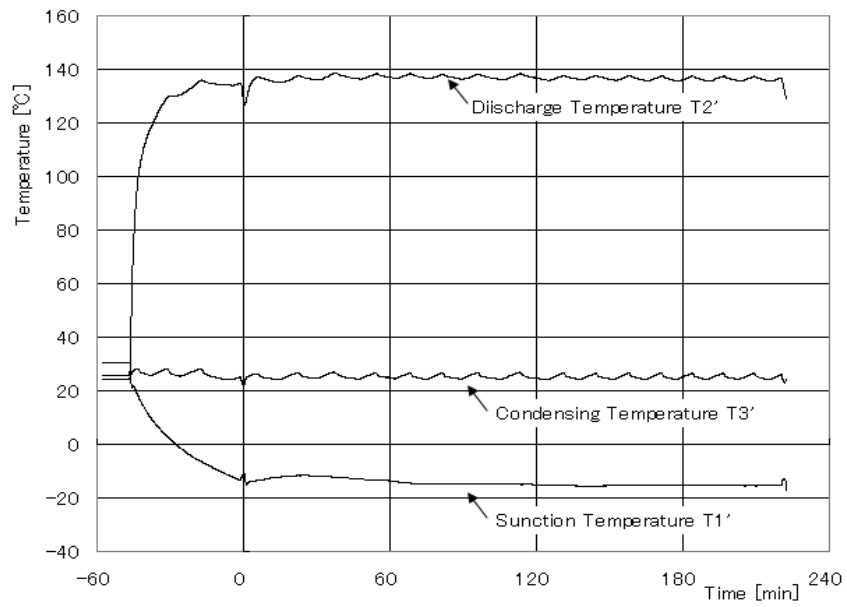
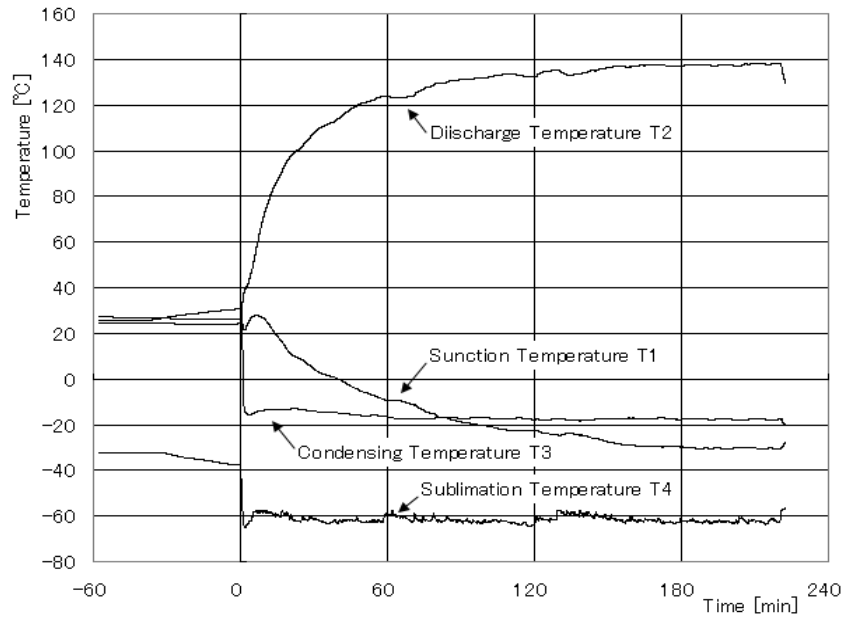

Fig 12. Variations of measured CO₂ pressures of HTC and LTC with time.



(a) Temperature at HTC



(b) Temperature at LTC

Fig 13. Variations of measured temperatures with time.