

HIGH EFFICIENT 18-90 m³/h R744 COMPRESSOR

Armin HAFNER^(a), Maria JUSTO ALONSO^(a), Christian SCHMÄLZLE^(b) Petter NEKSÅ^(a)

^(a) SINTEF Energy Research, Kolbjørn Hejes v. 1D, 7465 Trondheim, Norway. Armin.Hafner@sintef.no

^(b) OBRIST Engineering GmbH, Rheinstrasse 26-27, 6890 Lustenau, Austria. office@obrist.at^{Organization},

Abstract

A flexible compressor and heat exchanger test facility has been built and installed in the laboratories of SINTEF and NTNU in Trondheim. It enables a thorough investigation of higher capacity R744 components like compressors, heat exchangers, expansion- and work recovery devices. The maximum electrical power input to the compressor is in the range of 100 kW. Various plate heat exchangers are applied as a baseline equipment to be able to investigate real system operations from evaporation temperatures around the triple point of R744 to maximum discharge pressures of 130 bar.

Single stage R744 compressors with variable volume flow rates in the range of 18 to 90 m³/h are not available in the market. Therefore a novel high efficient, 6 cylinder piston compressor has been developed in close cooperation between SINTEF and OBRIST Engineering. The paper describes briefly the design features of the compressor and the test facility,

Initial experimental results show an overall efficiency significant higher than state-of-the-art compressor concepts with ordinary asynchronous motors. Latest results will be presented and implemented in the paper.

Keywords

R744, Test facility, piston compressor

1 Introduction

Since the re-introduction of carbon dioxide (R744) as a working fluid by Lorentzen et al. (1992/1994/1995), many advantages of this natural substance are realized in various mobile and stationary applications ranging from heat pumps, air conditioning to refrigeration. During the last 20 years the availability of components for stationary R744 applications improved drastically, however, there is still a need for further developments to reach the variety range for components designed for low pressure refrigerants.

The developed and built R744 test facility for compressors and heat exchangers in the 100 kWel and 400 kW cooling capacity range is dedicated for development and benchmarking of R744 components.

The main philosophy behind the design of the test facility is to get a flexible device which allows the investigation of different components alignments such as parallel and serial heat exchanger configurations. A sufficient amount of high accuracy measurement devices enables a detailed study of heat exchanger performance and compressor efficiencies.

The main improvements and efforts made in this compressor development are related to,

- Thorough oil separation inside the electric motor on the suction side of the compressor.
- Well integration of a permanent magnet motor.
- Smart heat management of the compressor
- Advanced valve design to be able to operate at a large rpm range.
- Improved cylinder sealing concept to reduce blow by.
- Sophisticated internal pressure equalisation concept.

2 Test facility and measurement equipment

The schematic circuit layout (P&ID) of the test facility is shown in Figure 1.

A frequency converter controls the rpm of the compressor (1). The refrigerant conditions on the inlet and discharge side of the compressor are monitored and measured with dedicated pressure and temperature sensors. During a test campaign a special designed cylinder head plate can be installed, which allows to do pressure indication inside the cylinder. The efficiency of the frequency converter is calibrated, i.e. the electrical power input to the compressor may be measured upstream of the frequency converter. The refrigerant mass flow rate is measured upstream of the compressor suction port with a coriolis mass flow meter (13).

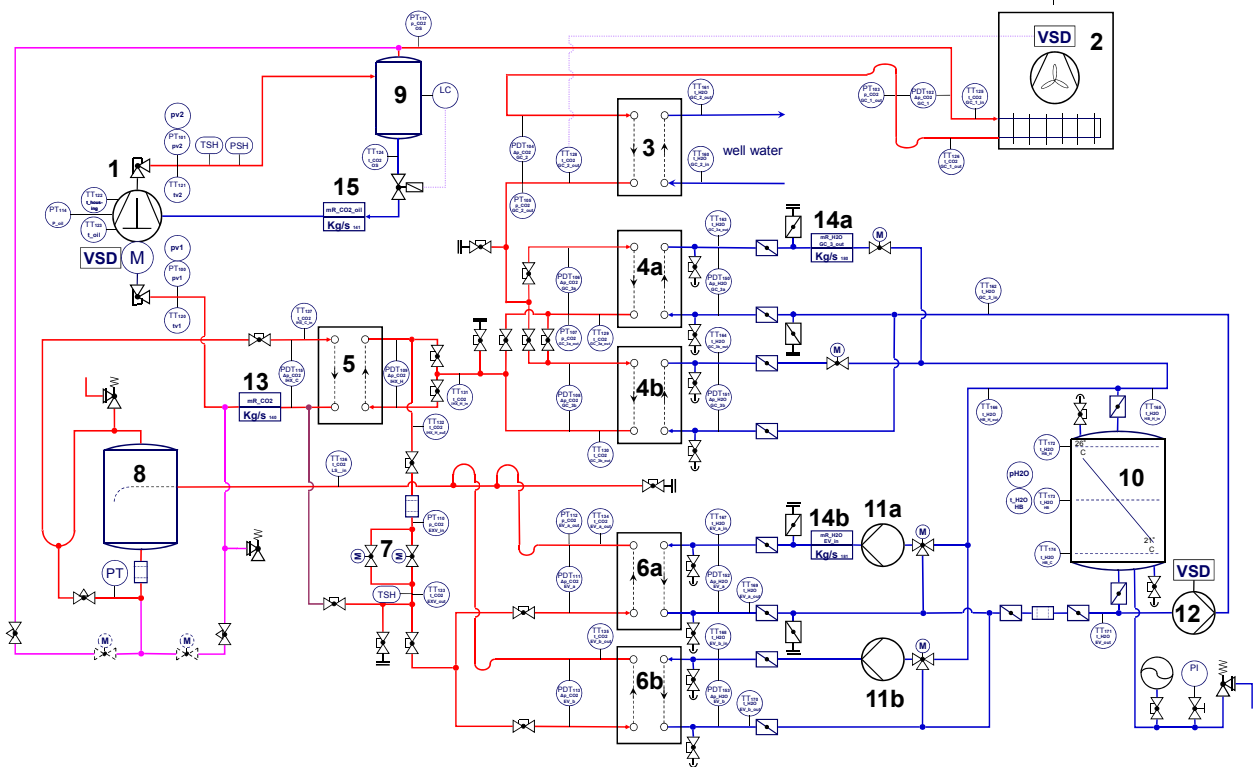


Figure 1: Schematic circuit of the test facility

The compressed refrigerant enters the oil separator (9) where most of the lubricant carry-over is accumulated and the lubricant flow rate back to the compressor crank case is measured by a coriolis mass flow meter (15). Thereafter the refrigerant flow enters the external cooling device (2). The gascooler/ condenser is able to reject the entire heat from the compressor power input to the ambient air. In case of an indoor installation of the entire test facility the refrigerant to liquid plate heat exchanger (3) is applied to reject the surplus heat to an external heat sink.

The temperature of the refrigerant flow rate is further reduced in the gascoolers/condensers (4a&b). Depending on the operating conditions these two heat exchangers can either be arranged in series or in parallel. The absolute pressure level is measured at the outlet port of each heat exchanger, as well as the pressure drop on both sides of the plate heat exchangers.

Downstream of the gascoolers an internal heat exchanger (5) is installed, able to exchange heat from the refrigerant flow upstream of the expansion devices (7) and the downstream flow of the low pressure receiver (8). The pressure drop across the internal heat exchangers is measured as well as the exit temperatures of the refrigerant flow. It is possible to bypass the entire internal heat exchanger on the high pressure side.

Two expansion devices (7) are installed which cover the wide operation range of the compressor. Depending on the refrigerant mass flow rates and required capacities, either one or both evaporators (6 a&b) are in operation. The low pressure receiver (8) accumulates the major charge of the system and separates the liquid out of the refrigerant flow downstream of the evaporators. A certain amount of liquid refrigerant including lubricant is entering the suction line upstream of the internal heat exchanger.

The plate heat exchangers (4a&b) are connected to the evaporators (6a&b) via a glycol loop. A storage tank (10) is required to maintain stable glycol temperatures into the heat exchangers. Due to the compact glycol system a full system analysis can be performed and only the power input to the compressor has to be rejected to maintain stable operation conditions. The glycol flow rates across 4a and 6a are measured as well as the pressure drops and inlet and outlet temperatures.

If only a compressor investigation takes place the refrigerant circuit can be operated without the main heat exchangers in a gas loop only, while the compressor heat is rejected either to the ambient (2) or to a liquid heat sink (3).

The entire test loop and the required control units are placed inside a 20 ft container. It can be moved to any field test side if required. The main components are accessible via two doors, i.e. at the front end between the electrical cabinets

and in the centre of the side wall, close to the compressor.

Table 1 lists the main measurement devices including range and accuracy.

Table 1: Applied measurement devices

Sensors	Measured variable	Measuring device	Calibration range	Calibrated accuracy
14	Temperature (°C)	K-type thermocouple	-40 -145	0.5
18	Temperature (°C)	PT100 Resistance thermometer	0 -140	0.03
13	Pressure (Bar)	Pressure gauge	0 -160	1.2
11	Pressure (Bar)	Pressure gauge	0 -80	0.7
1	Refrigerant mass flow rate (kg/s)	Coriolis mass flow meter	0.0-1.4	0.1% of reading
1	Lubricating oil (m ³ /h)	Coriolis mass flow meter	0 -4	0.25% of reading
1	Power consumption (kW)	Digital wattmeter	0-100	0.5% of reading
1	Compressor revolution speed (rpm)	Analog signal from the inverter drive	0-4000	1.3% of reading

A high efficient frequency converter is applied in the test facility to run the compressor between 800 and 4000 rpm. The main compressor data are shown in Table 2, while Figure 2 is a photo of the high performance 6-cylinder R744 compressor.

Table 2 Main Compressor data

	Value / Range
Height x Width x Length [mm]	500 x 440 x 830
Weight [kg]	286
Volume flow rate [m ³ /h]	18 - 90
Displacement [cm ³]	380
Max power consumption [kW]	100
Revolutions per minute [rpm]	800 – 4 000
Frequency range [Hz]	53 - 267

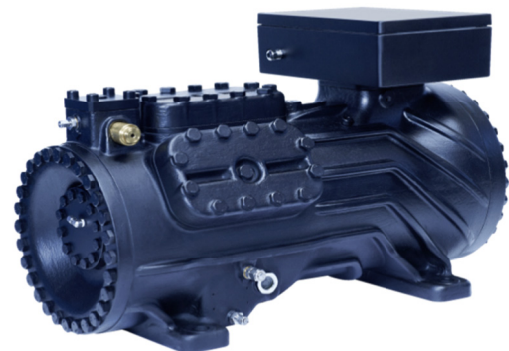


Figure 2: R744 compressor.

3 Experimental set up and results

The measured signals from the different transducers of the test facility are connected to data sampling modules which delivers the signals to the data acquisition tool (Labview). When steady state conditions are obtained the measured data are exported to an MS Excel based calculation sheet to further convert the measured data to useful results, i.e. efficiencies, performance data, etc. The uncertainties of the measurement and calculated results are estimated for each value. The calculation of the uncertainty values is done according to JCGM/WG1.

Experimental results obtained at 1500 rpm at a discharge pressure of 80 bar and a 10 K superheat at the compressor inlet are shown in Figures 3 and 4. As a reference measured values of two different R744 compressors from renowned manufactures are also implemented in the figures. The benchmark compressors were off the shelf, however, their displacement was only around 33% compared to the newly developed 6-cylinder unit.

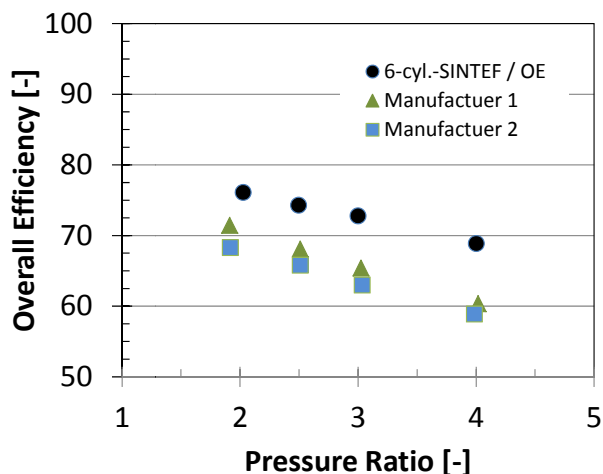


Figure 3: Measured overall efficiencies of R744 compressors.

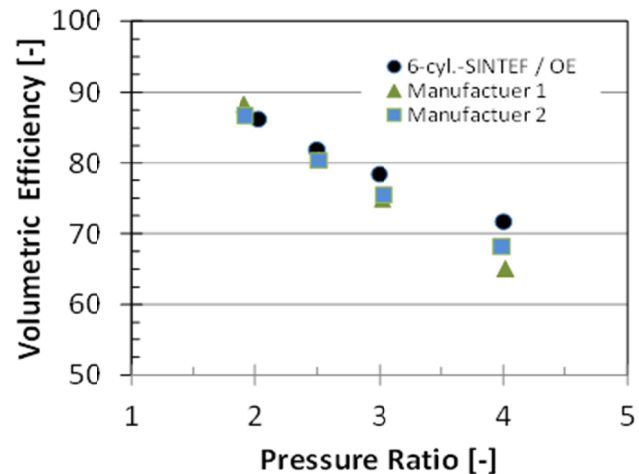


Figure 4: Measured volumetric efficiencies of R744 compressors.

The overall efficiency shown in Figure 3 afterwards is defined as shown in equation 1. The total mass flow rate is the sum of the refrigerant + lubricant mass flow rate. The isentropic enthalpy difference is calculated as the difference of the isentropic enthalpy at the discharge pressure (entropy of the compressor inlet) minus enthalpy at compressor inlet. The electric power consumption is measured, while the losses inside the frequency converter are subtracted.

$$\eta_{overall} = \frac{P_{is}}{P_{elec}} \cdot 100 = \frac{\dot{m}_{total} \cdot \Delta h_{is}}{P_{elec}} \cdot 100 \quad (1)$$

The volumetric efficiency shown in Figure 4 and afterwards is defined as shown in equation 2. The density is calculated based on temperature and pressure measurement at the suction side of the compressor.

$$\eta_{vol} = \frac{\dot{m}_{total}}{\dot{m}_{theoretical}} \cdot 100 = \frac{\dot{m}_{total}}{\rho_1 \cdot V_H \cdot n} \cdot 100 \quad (2)$$

Figure 5 shows the measured efficiencies at various compressor revolution speeds. The boundary conditions were: 32 bar suction pressure, 80 bar high side pressure and 10 K superheat at the compressor inlet.

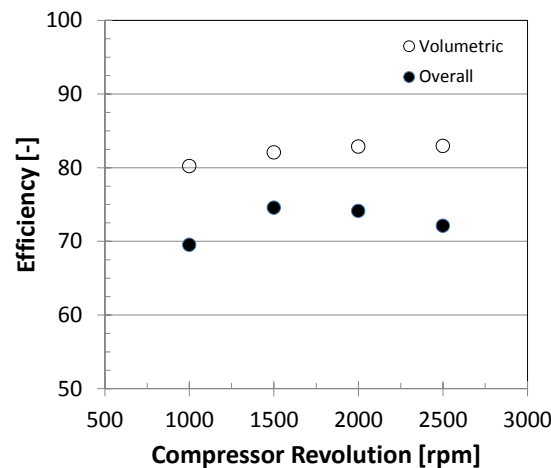


Figure 5: Measured overall efficiencies of the R744 compressor at 80 bar discharge pressure.

The oil circulation ratio (OCR) is calculated based on mass flow measurements of the lubricant separated of the main flow upstream of the compressor and the measured total mass flow rate at the suction side of the compressor.

The following test conditions have been experimentally investigated:

Superheat at compressor suction side:	10 K
Discharge pressure:	75; 90; 100 and 110 bar
Compressor revolution:	1000; 1500; 2000; 3000 and 3500 rpm

Results for a compressor suction pressure of 45 bar at various high side pressures and compressor revolutions are shown in Figures 6, 7 and 8.

Results for a compressor suction pressure of 35 bar at various high side pressures and compressor revolutions are shown in Figures 9, 10 and 11.

Results for a compressor suction pressure of 45 bar at various high side pressures and compressor revolutions are shown in Figures 12, 13 and 14.

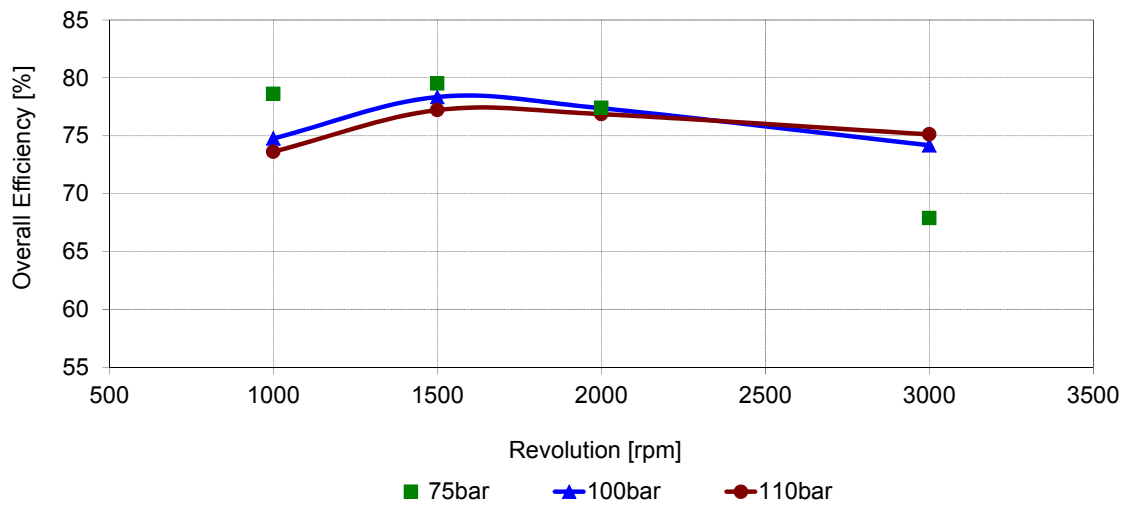
Results at 45 bar suction pressure

Figure 6 Overall efficiencies as a function of the compressor revolution for various high side pressures at an inlet pressure to the compressor of 45 bar.

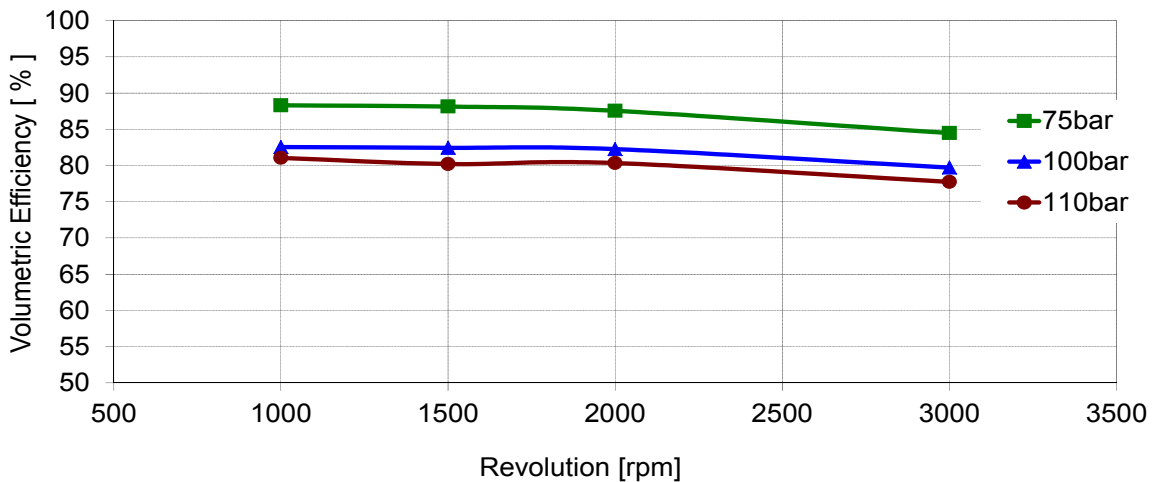


Figure 7 Volumetric efficiencies as a function of the compressor revolution for various high side pressures at an inlet pressure to the compressor of 45 bar.

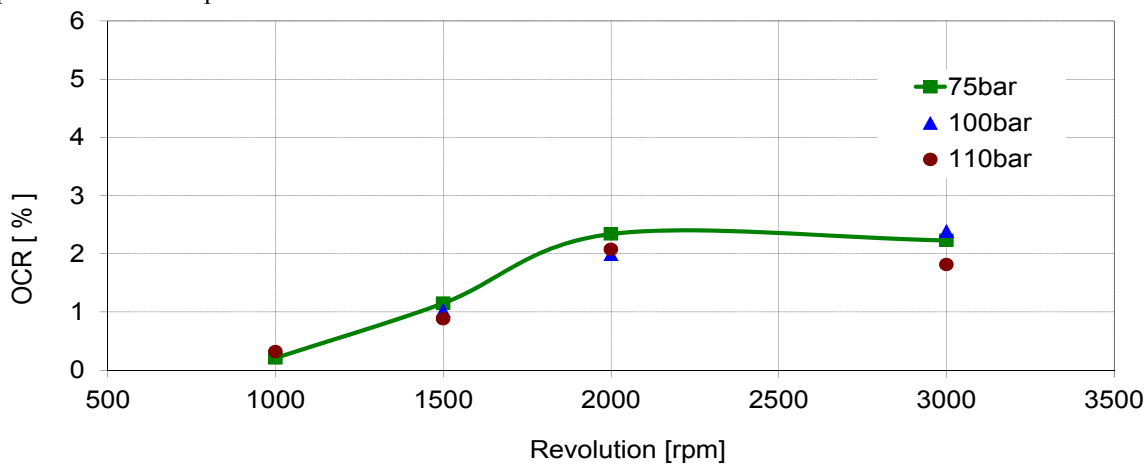


Figure 8 Oil circulation ratios as a function of the compressor revolution for various high side pressures at an inlet pressure to the compressor of 45 bar.

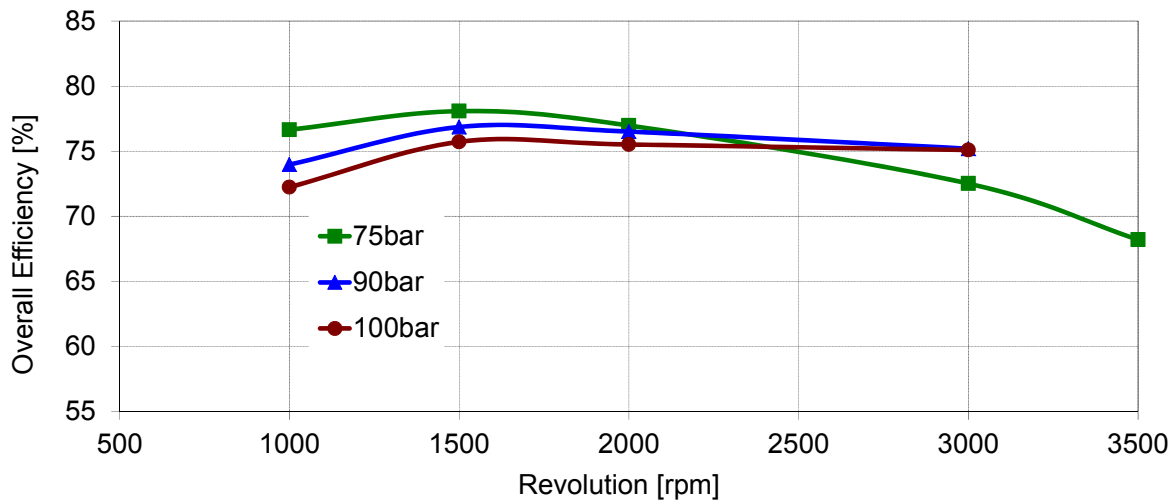
Results at 35 bar suction pressure

Figure 9 Overall efficiencies as a function of the compressor revolution for various high side pressures at an inlet pressure to the compressor of 35 bar.

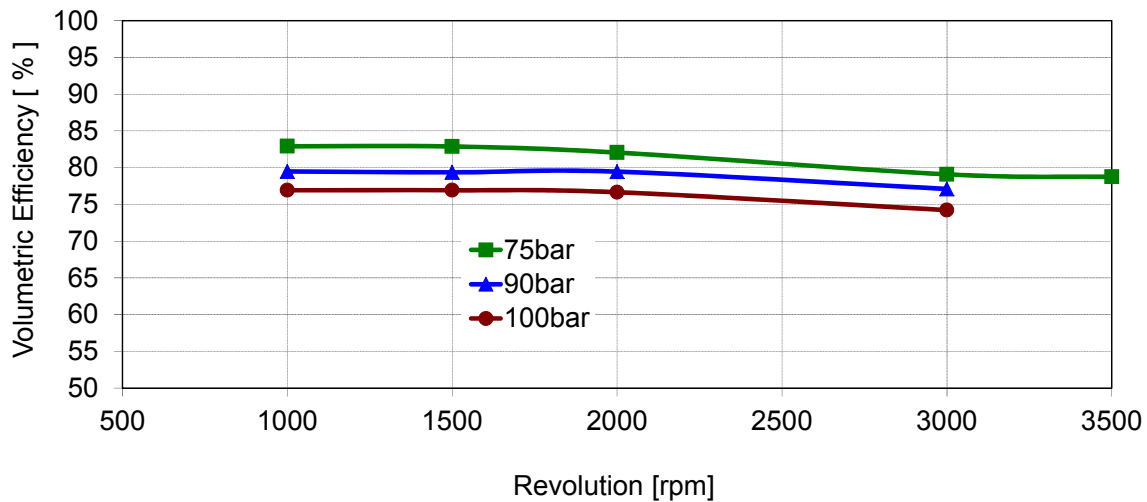


Figure 10 Volumetric efficiencies as a function of the compressor revolution for various high side pressures at an inlet pressure to the compressor of 35 bar.

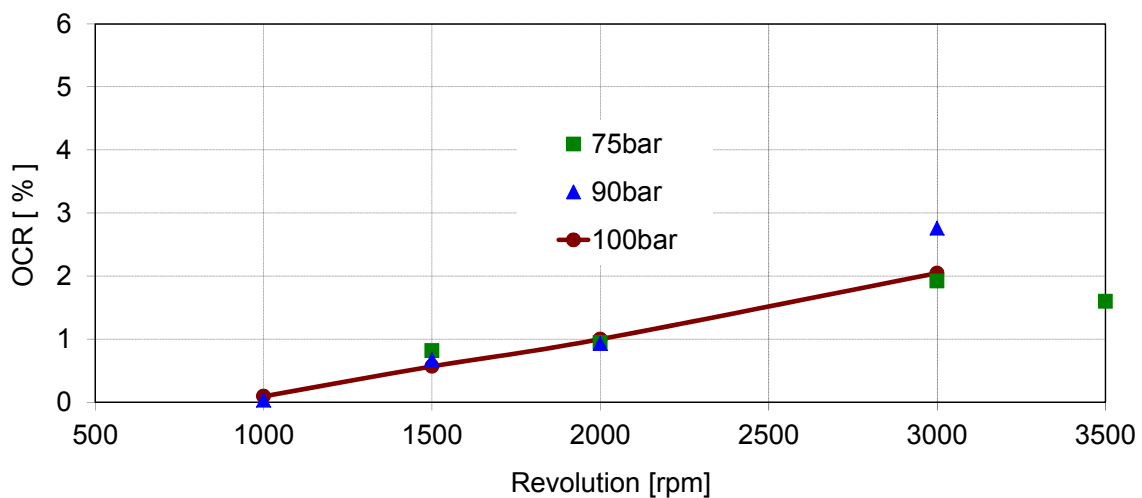


Figure 11 Oil circulation ratios as a function of the compressor revolution for various high side pressures at an inlet pressure to the compressor of 35 bar.

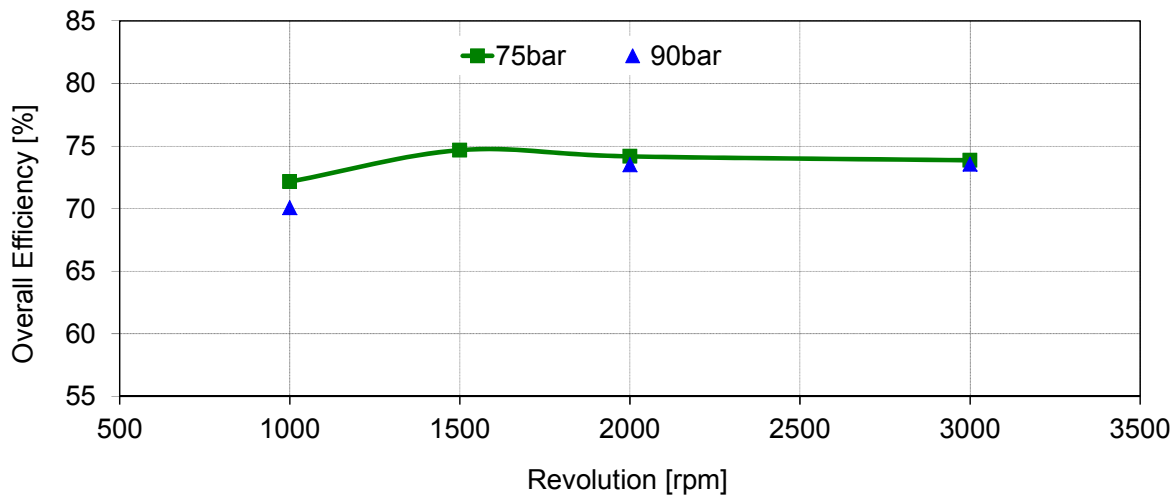
Results at 26 bar suction pressure

Figure 12 Overall efficiencies as a function of the compressor revolution for various high side pressures at an inlet pressure to the compressor of 26 bar.

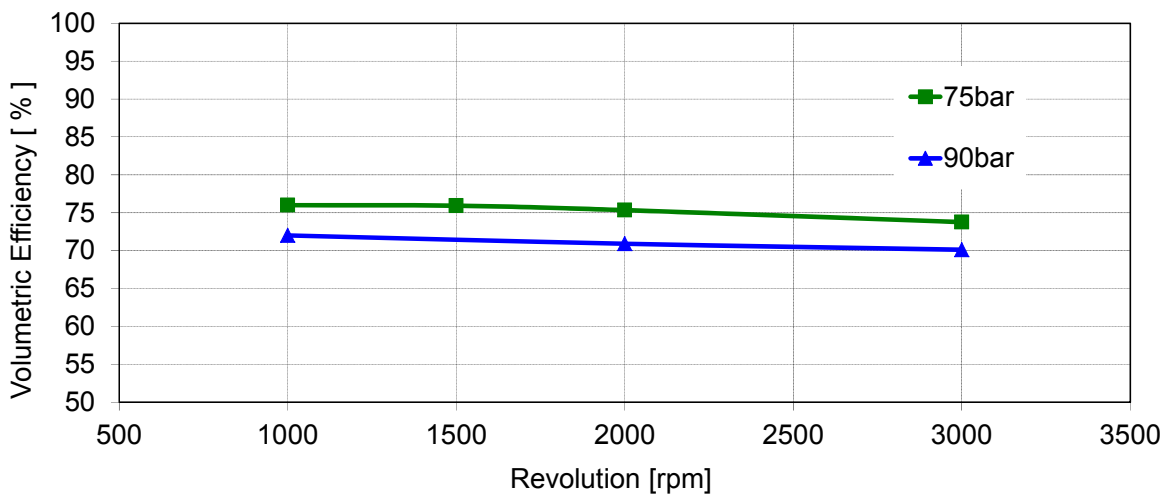


Figure 13 Volumetric efficiencies as a function of the compressor revolution for various high side pressures at an inlet pressure to the compressor of 26 bar.

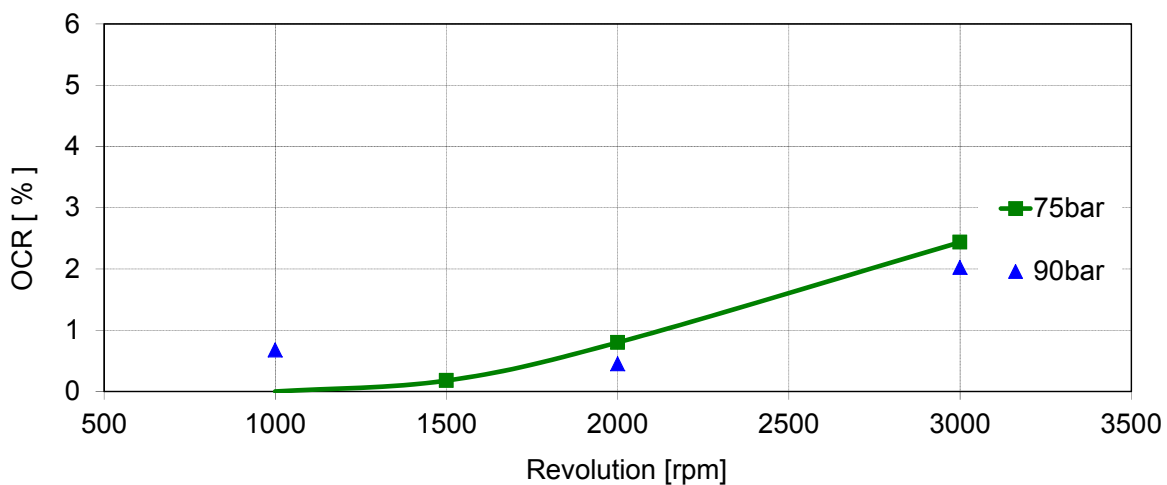


Figure 14 Oil circulation ratios as a function of the compressor revolution for various high side pressures at an inlet pressure to the compressor of 26 bar.



Results at 26 bar suction pressure

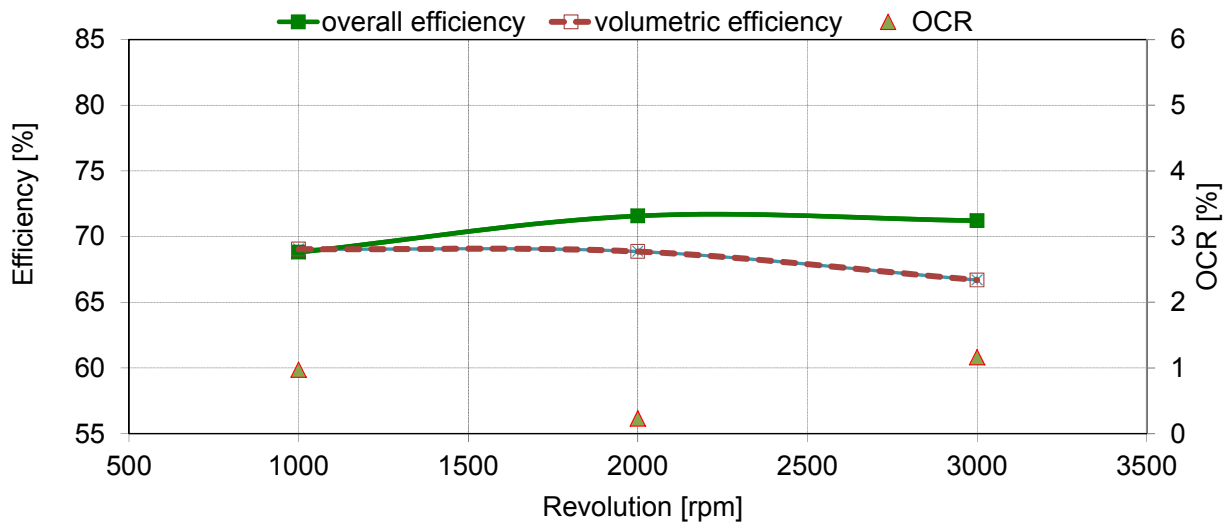


Figure 15 Efficiencies and oil circulation ratios as a function of the compressor revolution for an high side pressure of 75 bar at an inlet pressure to the compressor of 20 bar.

4 Discussion

The extensive measurement results indicates a significant efficiency improvement obtained with the new 6-cylinder R744 compressor developed in cooperation between SINTEF and Obrist Engineering GmbH. In the results the improvement is mainly due to permanent magnetic motor, since an ordinary valve arrangement and ordinary cylinder shaft sealing's are applied. Therefore a further improvement of both the overall and volumetric efficiency can be expected.

The overall efficiency is not decreasing at higher pressure ratios in the same way as it does with existing R744 piston compressor, as shown in Figure 3. This shows that the new concept has a large potential when applied in heat pumps, where due to large temperature lifts elevated pressure ratios might be the case.

The optimum, i.e. the highest overall efficiency values with the current valve arrangement are obtained between 1000 and 2000 rpm, as shown in Figure 5, 6 and 9. When analysing load profiles of ordinary refrigeration systems as applied in commercial refrigeration 80 % of the compressor operation could take place at these conditions, i.e. a high system COP can be achieved which results in a high energy efficiency of a supermarket as an example.

This compressor concept can help the industry and the end user to achieve the next level on the way to further improve the energy efficiency of energy intensive installations which contain heat pumping equipment. High temperature heat pumps and large commercial refrigeration plants are potential applications for this high efficient compressor concept.

5 Conclusion

A 100 kWel power and 400 kW cooling capacity test rig with multi-functional testing possibilities is presented. It allows measurements on R744 heat exchangers and compressors with detailed analysis possibilities. First test results are shown with test rig and the new developed 6 cylinder R744 compressor.

Currently compressor racks contain several compressors to be able to maintain low and high capacities, this concept with the wide capacity range allows replacing several ordinary compressors with a single compressor, i.e. the cost of installed cooling capacity is in the same range or even lower.

Initial results indicate that the performance of the 6 cylinder R744 compressor driven by a permanent magnet motor is close to the expected efficiencies as indicated by thorough simulations. Overall efficiencies of 80 % are measured. The compressor also shows favourable efficiency at a wide range of compressor revolution speeds.

A thorough test program for the compressor has now started in order to prove reliability and to analyse the distribution of losses of the compressor, utilising the new test facility. Several concepts will be tested, among these a novel compressor valve system not yet implemented. The compressor has also many novel elements already implemented, such as concepts for heat- and lubricant management that will be investigated in detail.

6 Acknowledgements

This paper has been written as part of the work within the research project CREATIV, which is financially supported by the Research Council of Norway and several industry partners.

7 Nomenclature

COP	Coefficient of Performance (-)
η_{overall}	Overall compressor efficiency (-)
η_{vol}	Volumetric compressor efficiency (-)
\dot{m}_{total}	mass flow rate (kgs-1)
n	Frequency of compressor (Hz)
Pelec	Measured compressor power consumption, excluding converter losses (W)
Pis	Isentropic power consumption (W)
R744	CO ₂
VH	Swept volume / compressor displacement (m ³)
Δh_{is}	isentropic enthalpy difference; enthalpy compressor outlet (at equal entropy as inlet) - enthalpy compressor inlet (kJkg-1)
ρ_1	refrigerant density at compressor inlet (kgm ⁻³)

8 References and Bibliography

1. JCGM/WG1, 100:2008, Evaluation of measurement data - Guide to the expression of uncertainty in measurement. BIPM, IEC, IFCC, ILAC, ISO, IUPAC and OIML, First edition 2008.
2. Lorentzen G., and Pettersen J., 1992. New Possibilities for Non-CFC Refrigeration. Proceedings from International Symposium on Refrigeration, Energy and Environment, Trondheim, pp. 147-163, June 22-24, pp. 147-163.
3. Lorentzen G., 1994. Revival of Carbon Dioxide as a Refrigerant. Int. Journal of Refrigeration, Vol. 17, No. 5, pp. 292-301.
4. Lorentzen G., 1995. The use of Natural Refrigerants: a Complete Solution to the CFC/HCFC Predicament. Int. Journal of Refrigeration, Vol. 18, No. 3, pp. 190-197.
5. Hafner A, C. Schmäzle, P. Nekså, F. Obrist and H. Rekstad, 2012. HIGH EFFICIENT 100 kWel R744 COMPRESSOR. Proceedings of the 10th IIR Gustav Lorentzen Conference on Natural Refrigerants, Delft, The Netherlands.