

HEAT RECOVERY IN FISH MEAL INDUSTRY BY HIGH TEMPERATURE HYBRID HEAT PUMPS

S. R.NORDTVEDT

Institute for Energy Technology, P.O. Box 40, NO-2027 Kjeller, Norway,
Fax: +47-63802905, Stein.Rune.Nordtvedt@ife.no

ABSTRACT

The fish meal industry uses large amount of heat for drying, and this paper presents results from a feasibility study of the possibilities for energy recovery by means of a hybrid heat pump. By hybrid heat pump means a vapour compression heat pump with a solution circuit. The working fluid is mixture of ammonia and water which gives many benefits where high temperatures are required and where the heat sink and heat source fluids have large temperature glides. A simulation model was developed to explore the possibilities for heat recovery using hybrid heat pumps, and results from parametric studies with simulation model are presented. The results show that hybrid heat pumps have promising capabilities for use in the fish meal industry.

1. INTRODUCTION

Fish meal is used worldwide as an ingredient in many feed products, of which fish feed accounts for the largest part. The inclusion levels in fish feed is between 30 – 50 per cent. The increased energy prices and marked competition gives more focus on means for reduction of the energy use in the fish meal production. The total energy use in the Norwegian fish industry was 1119 GWh in 2006, of which 585 GWh electric power and 534 GWh thermal energy (Helgerud, Rosenberg et al. 2007). Production plants for fishmeal accounts for the largest share (about 75%) of thermal energy (oil and gas). Typical distributions of energy use between the different production processes in the production of fish meal are: drying (53%), boiling (24 %), evaporation (14 %), liquid heating (6 %) and misc. (3 %). This means that 283 GWh is used for drying of fish meal per year in Norway and that the drying process is the unit operation with the largest potential for energy reduction in fish meal production.

2. THE FISH MEAL AND FISH OIL PRODUCTION PROCESS

Production of fishmeal and fish oil is an energy intensive process. Fish meal and oil are produced from fish that are not suitable for human consumption, such as sand eel, blue whiting, capelin and pout in addition to trimmings from the fish processing industry. Such interceptions accounts for 15 - 20% of production. The raw material contains on average 75% water, 3% oil and 22% solids. The production process consists in separating oil and solids in a gentle manner that preserves the nutritional content of the final product. A schematic diagram for the production of fishmeal is shown in Figure 1.

The raw material is pumped from the boat over in storage tanks, and a small amount of water is added (about 3-4% of total volume). The first step of the manufacturing process is boiling. The purpose of the boiling is to free the fat in fish and prevent bacteriological problems later in the process. The boiling is also important to achieve optimum quality and yield on production. Boiling takes place in practice in the temperature interval 70-95 ° C. The residence time is relatively short. Simplified described the boiling is done in a lying cylinder where the raw material is passed through by means of a screw conveyor. Often the sheath cylinder walls are heated by steam.

After boiling the mass is transported over a sieve which a liquid phase is separated off. The remaining solids go to a press. The main purpose of the press is to separate the mixture into two phases; press liquid consisting of water and oil, and press cake that will be as dry as possible with little fat.

The press liquid is pumped to a decanter (centrifuge) where most of the dry matter remaining in the press liquid is separated out. The dry matter excreted, called greaves, is sent to a mixing vessel where it is mixed with the press cake coming from the press. The remaining liquid is pumped to a separator (centrifuge) where the fat is separated from the liquid. The residual liquid is called stick water and passed to an evaporator for removal of most of water. The evaporator concentrate is mixed with the press cake and greaves at the dryer inlet. The water content of the solid mixture is reduced to about 8% by drying. A thorough description of the fish meal and fish oil production process can be found in (FAO 1986).

Indirect steam dryers and hot air rotary dryers are the most commonly used dryers in Norway today (Flesland, Høstmark et al. 2000). The dryers are robust and able to handle different feed material. The indirect steam dryers are mostly used as pre-dryers because of the higher heat loads on the product following the high surface temperatures within the dryers. The hot air inlet temperatures are typically 350 to 400°C, and the air outlet temperatures are approximately 90°C. The product temperatures do not exceed 75-80°C. The exhaust air from the hot-air dryers is directed through cyclones to remove remaining meal, cooled and dehumidified in a sea water wash tower. The cooled and dehumidified air is then indirectly heated by the hot flue gases from an oil- or gas burner. Biomass fired burners are also used.

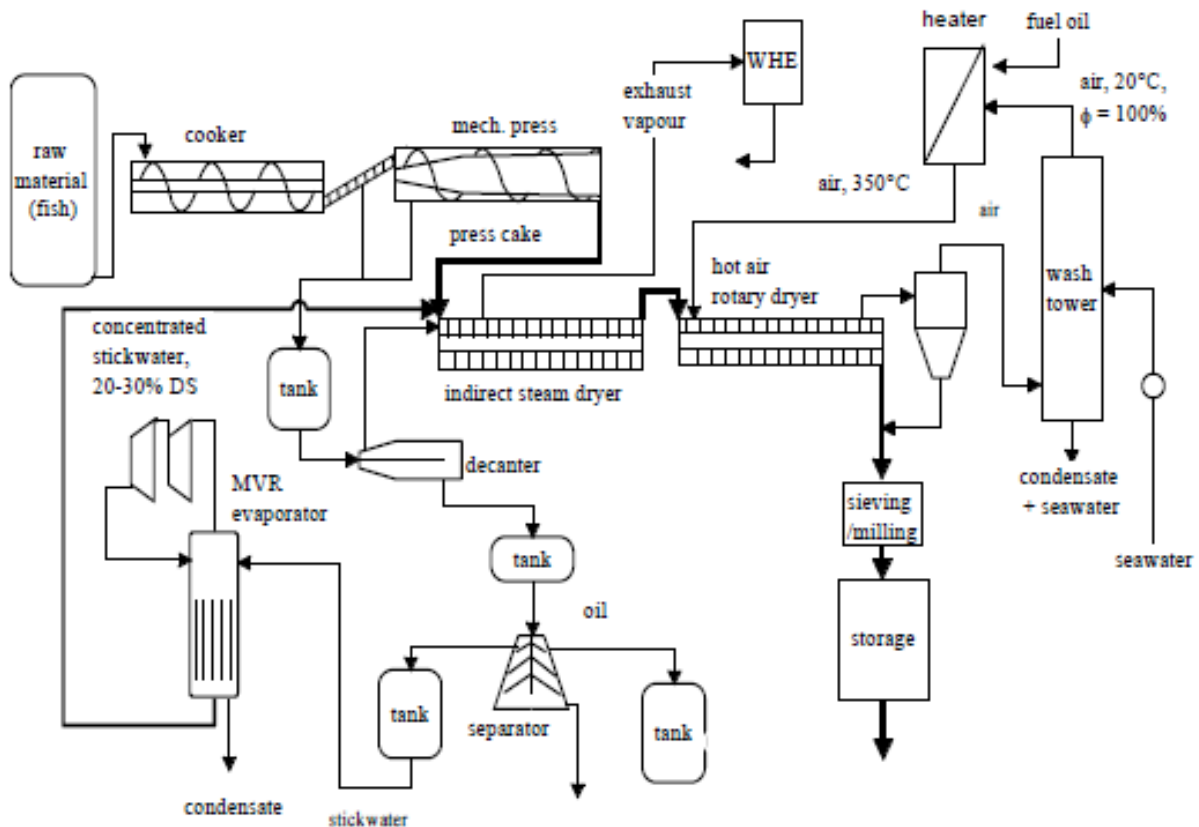

Figure 1 Production flow for fishmeal and fish oil

3. THE HYBRID HEAT PUMP PROCESS

The hybrid heat pump process is a vapour compression cycle with a solution circuit where the working fluid mixture consists of a refrigerant and an absorbent. The working fluid mixtures are normally wide-boiling mixtures. Figure 2 shows a flow scheme of a simplified flow scheme of a two-stage hybrid heat pump. Two-stage compression is required for high temperature lift applications. The temperature lift is defined as the temperature difference between heat sink outlet temperature and the heat source outlet temperature. The working fluid mixture, strong in refrigerant, is partly evaporated by heat dissipated from the heat source fluid in the desorber and the vapour/liquid mixture leaving the desorber is separated in a gas/liquid separator. The liquid solution weak in refrigerant is pumped to high pressure and enters the absorber. The vapour are compressed to high pressure in the compressors and enters the absorber where it is absorbed into the solution weak in refrigerant, thereby releasing heat to the heat sink fluid. The solution, strong in refrigerant, is then recirculated to the desorber through the expansion valve. The solution heat exchanger and the intermediate heat exchanger are important for internal heat recovery and the cycle coefficient of performance.

The vapour compression heat pump cycle with solution circuit offer a number of attractive advantages in comparison with conventional vapour compression heat pumps: (1) high heat sink fluid temperatures can be achieved at standard pressures (below 25 bars), (2) variation of capacity by changing the average composition circulating between the absorber and the desorber, and (3) the temperature glide of the working fluid mixture can be matched to the heat sink and heat source fluid temperature glide thereby reducing the heat exchange losses.

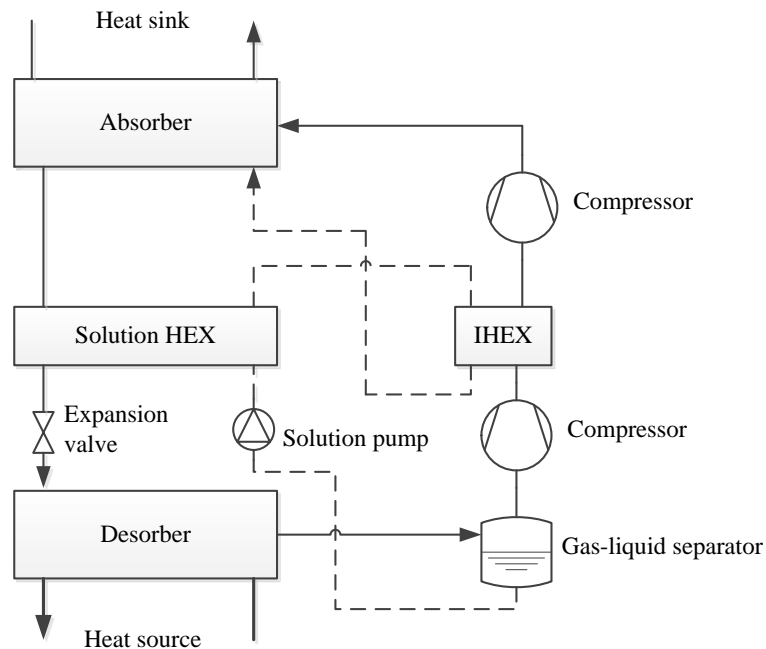

Figure 2 Simplified flow scheme of the two-stage hybrid heat pump system

4. HEAT RECOVERY IN THE FISH MEAL PROCESS

The drying of the mixture of press cake, greaves and stick water concentrate is the most energy demanding unit operation in fish meal process due to the high specific energy demand for dehumidification with the hot-air dryers. A schematic layout of a hot-air dryer with a sea water scrubber tower and an indirect air heater is shown in Figure 3. Hot dry air dries the mixture of press cake, greaves and stick water in the dryer. The humid air leaving the dryer is transported to the sea water scrubber tower by means of ventilation fans and water is removed from the air by condensation. The dehumidified air is then transported to the air heater where it is indirectly heated by the hot combustion gases from a gas-, oil- or biomass fired burner.

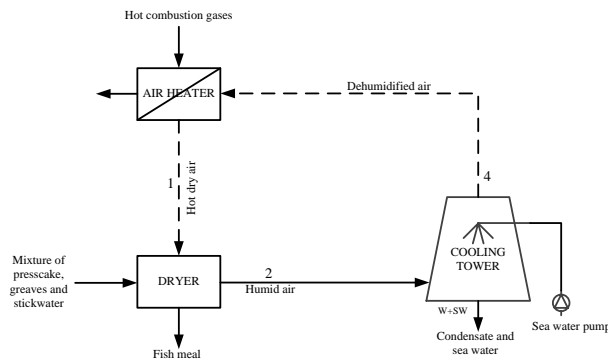

Figure 3 Simplified flow scheme of hot-air dryer with sea water wash tower and air heater (case 1)

In this study, a comparison of three different cases is done. Case 1 is the base case without heat recovery as shown in Figure 3. Case 2 is with heat recovery by indirect heat exchange between the dryer exhaust air and the cooled and dehumidified air coming from the sea water scrubber tower. Case 3 is with heat recovery by a hybrid heat pump extracting heat from the dryer humid exhaust air and heating the cooled and dehumidified air coming from the sea water scrubber tower. In addition the heat pump can deliver heat to other processes in the production process; for example to heat different storage tanks in the production process and to preheat the raw material before the boiler. Figure 4 and Figure 5 show simplified layouts of case 2 and case 3.

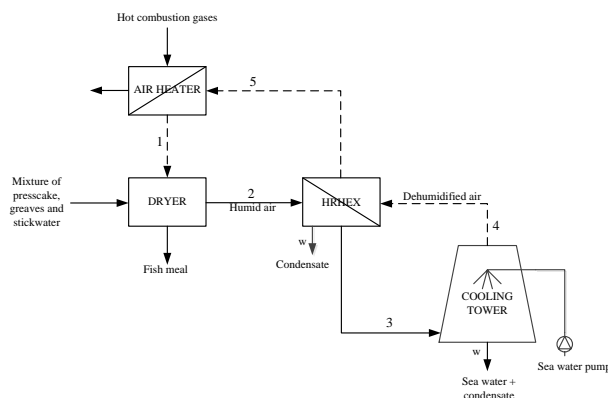

Figure 4 Simplified flow scheme of hot air dryer with heat recovery heat exchanger (case 2)

Table 2 State point data for the calculations

State#	Case 1		Case 2		Case 3-1		Case 3-2		Case 3-3	
	T[°C]	Rh[%]	T[°C]	Rh[%]	T[°C]	Rh[%]	T[°C]	Rh[%]	T[°C]	Rh[%]
Mix in	75		75		75		75		75	
Fish meal out	80		80		80		80		80	
1	350		350		350		350		350	
2	85		85		85		85		85	
3			calc		55		55		50	
4	20	100	20	100	20	100	20	100	20	100
5			calc		80		100		100	
6					70		70		70	
7					50		50		45	
8					90		110		110	
9					60		60		60	

6. RESULTS

The energy use of the hot-air dryers can be significantly reduced with the help of heat pumping technology. The specific energy use varies from 1.2 kWh per kg of water removed for the base case without heat recovery, to 0.95 kWh per kg of water removed by recovering heat from the dryer humid exhaust air with hybrid heat pumps. This represents a reduction of 21% of the energy use for dehydration with hot-air dryers. A 15% reduction can be achieved with pure heat exchange between the humid exhaust air leaving the drying section and the cooled dehumidified air leaving the sea water scrubber tower. Additional savings can be achieved with heat pumps if the recovered heat can be used elsewhere in the production process.

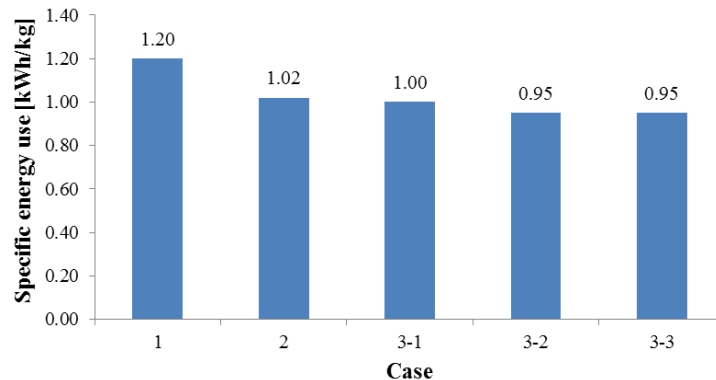

Figure 6 Specific energy uses for the different cases

The heat loads on the heat recovery heat exchanger (HRHEX) and the heat exchangers on the hot side of the heat pump (HEX1 and HEX2) are shown in Figure 7. HEX1 preheats the cooled dehumidified air coming from the sea water scrubber tower before entering the air heater, and HEX2 heats potentially other processes in the fish meal production process. The heat pump outlet temperature is increased from 90°C to 110°C in case 3-1 to case 3-2, thereby increasing the heat delivered in HEX1 from 894kW to 1192kW. The dryer exhaust air is cooled to 55°C in case 3-1 and 3-2, which is below the dew point of 57.8°C. A further cooling of the dryer exhaust air to 50°C increases the heat load on the heat pump cold side from 1213kW to 2274kW, and increases the heat load in the HEX2 from 273kW to 1577kW. The size of the heat pump is set by the heat needed elsewhere in the production process.

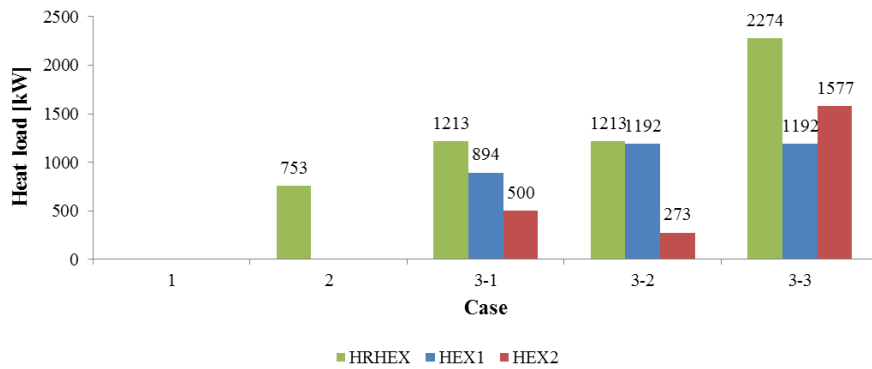

Figure 7 Heat loads on HRHEX, HEX1 and HEX2

Heat recovery from the dryer exhaust air reduces the heat loads on both the air heater and the sea water scrubber tower. The reduced heat load on the air heater gives large reductions in the CO₂ emissions if the air heater is oil- or natural gas fired.

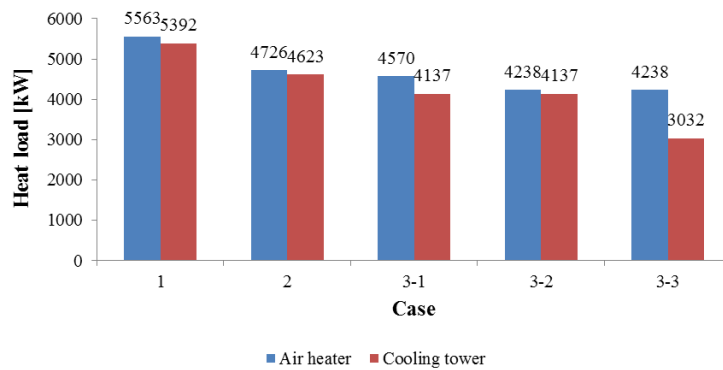

Figure 8 Heat loads on air heater and cooling tower

7. CONCLUSION

The energy use for the production of fish meals can be significantly reduced if heat pumps are used to recover heat from the hot-air dryer humid exhaust air. The specific energy use of the hot-air dryers can potentially be reduced by 20% by implementing hybrid heat pumps into the plants. Further reductions of the total plant energy consumption may be achieved if recovered is used elsewhere in the fish meal production process.

8. ACKNOWLEDGEMENTS

This publication forms a part of the CREATIV project, performed under the strategic Norwegian research program RENERGI. The author acknowledges the partners: Danfoss, FHL, Hydro Aluminium, John Bean Technology, REMA1000, Systemair, TINE, and the Research Council of Norway (195182/S60) for their support.

REFERENCES

FAO (1986). The production of fish meal and oil. Rome.

Flesland, O., Ø. Høstmark, T. A. Samuelsen and Å. Oterhals (2000). Selecting drying technology for the production of fish meal. IDS.

Helgerud, H. E., E. Rosenberg, T. M. Risberg and H. M. Mydske (2007). Store energipotensialer i næringsmiddelindustrien, Energieffektivisering i næringsmiddelindustrien - en potensialstudie. E. rapport. **2007:6**.